

NOVA™

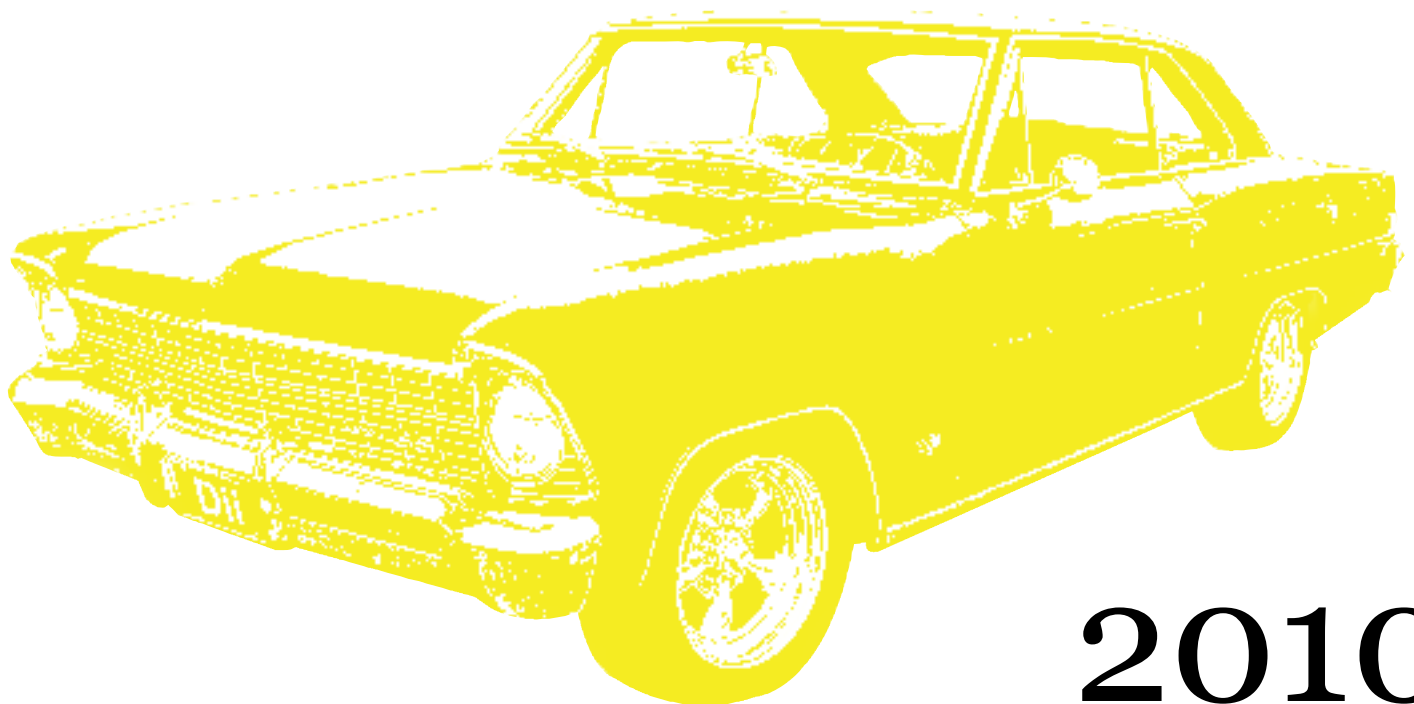

2010

Golden Leaf Automotive

Nova™ Index

A

A/C Vent & Bezel: 37
Arm Rests & Bases: 26

B

Battery Trays & Clamps: 5
Body Bushing Kit: 40
Body Shims & Washers: 3
Body Side Molding: 33
Brake Pad & Trim: 34
Brake Release Handle: 34
Bumpers: 1
 Bolt Kit: 1
 Brackets: 1
 Fillers: 2

C

Cigarette Lighter: 40
Clothes Hanger Hooks: 40
Clutch & Accelerator Pads & Trim: 35
Control Arm Bumper: 40
Cowl Panels: 7

D

Dash Panel, Steel: 7
Dash A/C Vent & Bezel: 27
Decal: 37
Deck Lid Filler Panel: 16
Dome Light & Lens: 40
Door:
 Handles: 24
 Hinge & Roller: 25
 Latch & Relays: 25
 Lock Knobs: 25
 Molding: 33
 Shells & Skins: 23
 Window Tracks, Lower: 24
Drip Rail Moldings: 32

E

Emblems: 26
Engine Mounts: 8
Eyebrow Molding: 29

F

Fan: 21
Fender: 2, 3
 Front Inner: 4
Fender to Valance Brackets: 2
Firewall: 9
Floor Pans: 9-12
 Plug: 9
 Rear Seat, with braces: 13
Frame Rails & Braces: 13
Fuel Sending Units: 19
 Gasket & Locking Rings: 19

Fuel Tank: 18
 Straps: 20

G

Gas Caps: 20
Grilles: 27-29

H

Headlamp:
 Bezel: 27-29
 Buckets: 28
 Retaining Ring: 27-29
 Switches: 39
Heater Blower Motor: 38
Heater Boxes & Case: 38
Hood: 6
 Hinges: 7
 Latches & Supports: 8
 Louvers & Brackets: 7
 Moldings & Spear: 30
Horns: 40
Horn Buttons & Contacts: 35

I

Inner Trim & Molding, Door & Qtr.: 33

L

Locks: 41
License Plate Bracket: 17
License Plate Lamp: 39

M

Mirrors:
 Exterior: 32
 Interior: 36

P

Parking Brake Assembly: 34
Parking Lamp:
 Assemblies: 39
 Extension Molding: 33
 Lenses: 38
 Bezels: 39
Pitman Arm: 40

Q

Quarter/Door Frame Assy.: 14
Quarter Panels: 15
Quarter Panel Skins: 16
Quarter Trim Molding: 33
Quarter Window Molding: 30

R

Radiator Supports: 5

Radio Bezel: 37
Rear Body Panel: 16
Rocker Panel: 13
 Moldings: 33
Roof Drip Rails: 8
Roof Panel & Braces: 9

S

Scuff Plates: 33
Seat
 Belt Buckle Cover: 37
 Belts: 42
 Frame Assembly: 14
 Frame Supports: 14
 Knobs: 37
 Track Assembly, Bench: 14
Shifter Assembly: 34
Shock Tower Assembly: 3
 Components: 4
Shoulder Harness Hooks: 40
Side Markers & Bezels: 38
Spring Saddle & Seat: 4
Stabilizer Rod & Bushing: 34
Steering Wheels: 35, 36
 Hubs: 35
Sun Visor Support: 37

T

Tail Lamp Assembly: 39
 Panels: 17
Transmission Mt. Crossmember: 13
Trunk:
 Divider/Package Shelf: 21
 Floor Drop Offs: 22
 Floor Pans: 22
 Hinges & Latches: 21
 Lids: 20
 Molding: 31

V

Valance Molding: 30
Vent Window Crank: 25
Vinyl Top Molding: 31

W

Wheelhouses: 16
Wheel Centers: 37
Wheel Opening Moldings: 30
Window Cranks: 24
Window Moldings, Rear: 31
Windshield Moldings: 31
Windshield Pillar Panels: 8
Windshield Washer Bottle Bracket: 4

Wholesale Only. MSRP not including Taxes, Shipping and Handling. MSRP are subject to change without notice.

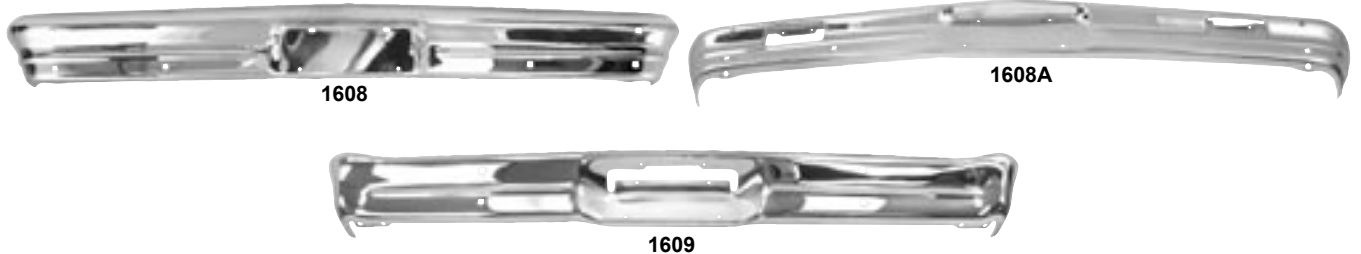

1608	1962-64	Front Bumper		MSRP \$219.00 ea
1608A	1965	Front Bumper		MSRP \$219.00 ea
1609	1962-65	Rear Bumper		MSRP \$219.00 ea



1610	1966-67	Front Bumper, Chrome		MSRP \$219.00 ea
1611	1966-67	Rear Bumper, Chrome		MSRP \$219.00 ea

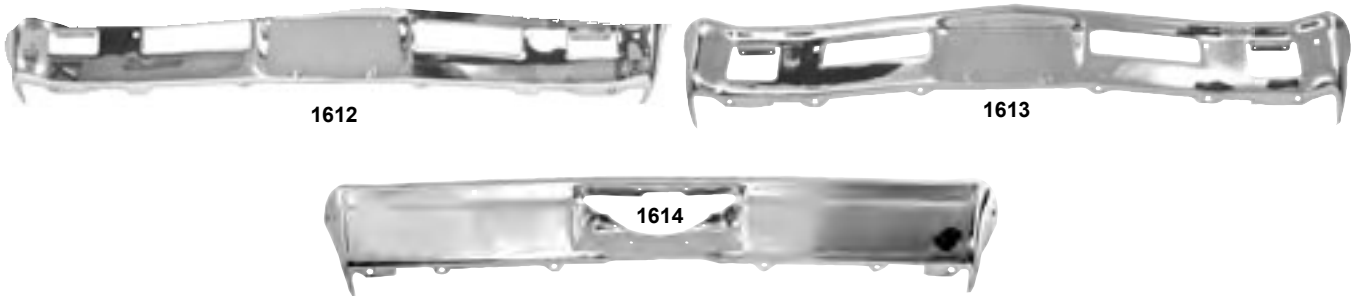

1612	1968-69	Front Bumper, Chrome		MSRP \$219.00 ea
1613	1970-72	Front Bumper, Chrome		MSRP \$219.00 ea
1614	1968-72	Rear Bumper, Chrome		MSRP \$219.00 ea



1611A	1966-67	Rear Bumper Bracket, RH
1611B	1966-67	Rear Bumper Bracket, LH

MSRP \$49.00 ea

1614A	1968-72	Front Bumper Brackets, RH 2 pcs.
1614B	1968-72	Front Bumper Brackets, LH 2 pcs.

MSRP \$62.00 set

Bumper Brackets



1610A	1964-72	Bumper Bolt Kit
-------	---------	-----------------

MSRP \$19.00 kit

Bumper Bolt Kit

Bumper Fillers



1615A	1962-65	Front Bumper Filler
1615B	1966-67	Front Bumper Filler
1615C	1968-72	Front Bumper Filler, Metal
1615D	1968-72	Front Bumper Filler, Fiberglass

MSRP \$87.00 ea

MSRP \$54.00 ea

Fender to Valance Brackets

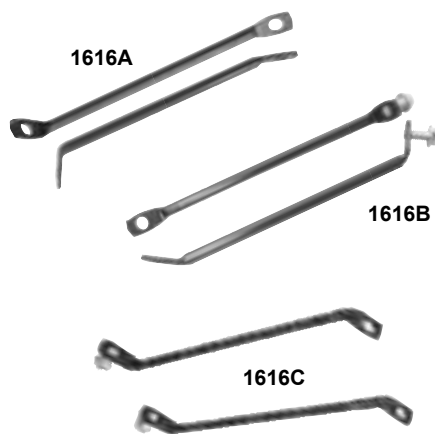

1616A	1962-65	Fender to Valance Brackets
1616B	1966-67	Fender to Valance Brackets
1616C	1968-72	Fender to Valance Brackets

MSRP \$12.00 pr

Front Fenders

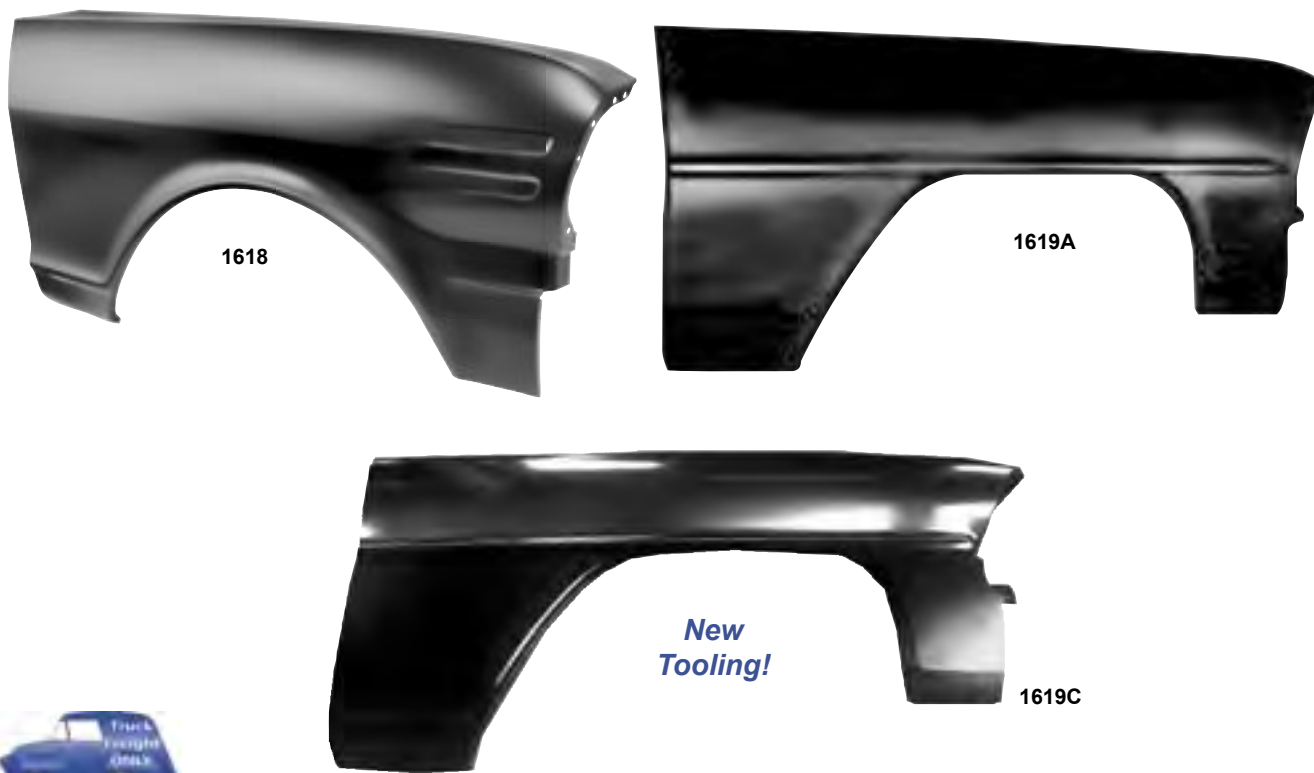

1618	1962-65	Front Fender RH	MSRP \$267.00 ea
1619	1962-65	Front Fender LH	MSRP \$267.00 ea
1619A	1966	Front Fender RH	Call
1619B	1966	Front Fender LH	Call
1619C	1967	Front Fender RH	MSRP \$515.00 ea
1619D	1967	Front Fender LH	MSRP \$515.00 ea

New Tooling!

New Tooling!

Wholesale Only. MSRP not including Taxes, Shipping and Handling. MSRP are subject to change without notice



1616	1968-69	Front Fender RH	MSRP \$515.00 ea
1617	1968-69	Front Fender LH	MSRP \$515.00 ea
1617A	1970-72	Front Fender RH	MSRP \$515.00 ea
1617B	1970-72	Front Fender LH	MSRP \$515.00 ea



1000F



1000D

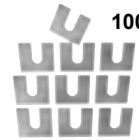

1000E



GM03

1000F	1964-72	Body Shims, 6 mm., 10 pc. set	MSRP \$12.00 set
1000D	1964-72	Body Shims, 3 mm., 10 pc. set	MSRP \$7.00 set
1000E	1964-72	Body Shims, 1.6 mm., 10 pc. set	MSRP \$7.00 set
GM03		Body Washers, 20 pc. set	MSRP \$20.00 set

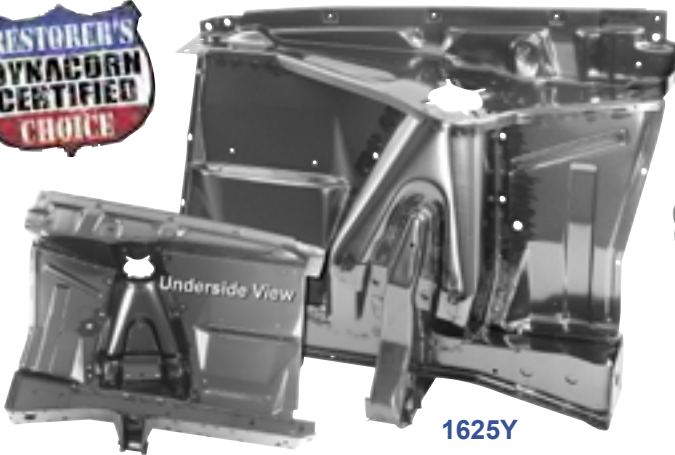

1625Y

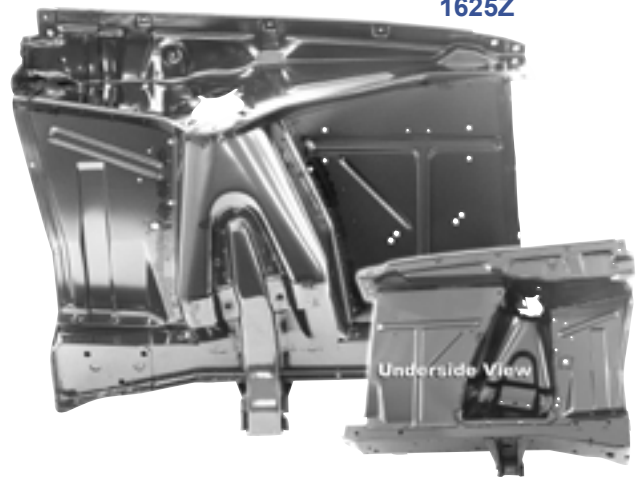

1625Z

1625Y	New	1966-67	Shock Tower & Apron Assembly, RH	MSRP \$870.00 ea
1625Z	New	1966-67	Shock Tower & Apron Assembly, LH	MSRP \$870.00 ea

Wholesale Only. MSRP not including Taxes, Shipping and Handling. MSRP are subject to change without notice

Shock Towers, Panels



1627C	New	1966-67	Shock Tower, 3 pieces, RH	<i>Coming Soon!</i>
1627D	New	1966-67	Shock Tower, 3 pieces, LH	<i>Coming Soon!</i>

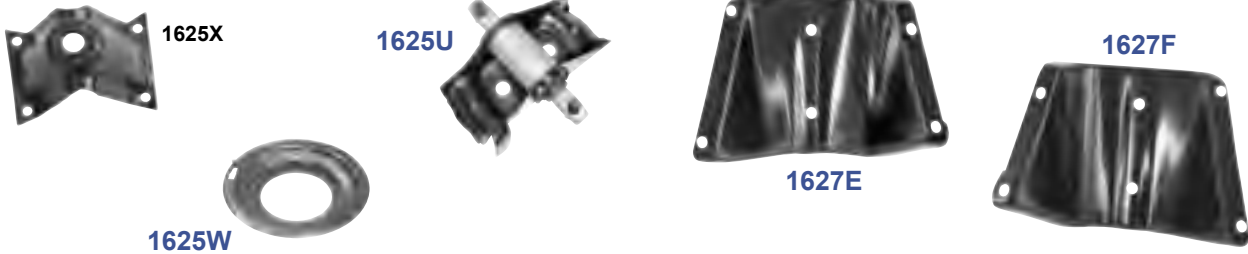

1625X		1966-67	Shock Tower Cap	MSRP \$45.00 ea
1625W	New	1966-67	Spring Upper Seat	MSRP \$30.00 ea
1625U	New	1966-67	Spring Saddle	MSRP \$74.00 ea
1627E	New	1966-67	Outer Shock Tower Panel, RH	MSRP \$65.00 ea
1627F	New	1966-67	Outer Shock Tower Panel, LH	MSRP \$65.00 ea

Front Inner Fenders



1625S	New	1966-67	Front Inner Fender, RH
1625T	New	1966-67	Front Inner Fender, LH

Coming Soon!

1626		1968-72	Front Inner Fender, RH
1627		1968-72	Front Inner Fender, LH

MSRP \$145.00 ea

Washer Bottle Bracket



1425		1964-69	Windshield Washer Bottle Bracket
------	--	---------	----------------------------------

MSRP \$15.00 ea

Wholesale Only. MSRP not including Taxes, Shipping and Handling. MSRP are subject to change without notice



1639



1640

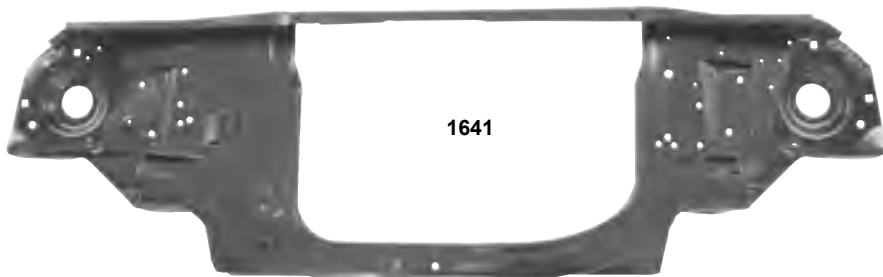

1641

1639A	New	1962-64	Radiator Support	<i>Coming Soon!</i>
1639B	New	1965	Radiator Support	<i>Coming Soon!</i>
1639		1966-67	Radiator Support	MSRP \$305.00 ea
1640		1968-74	Radiator Support, For 6 cylinder	MSRP \$204.00 ea
1641		1968-74	Radiator Support, For 23" Radiator, all engines	MSRP \$204.00 ea



1620



1047E

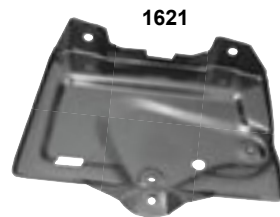

1621

1620		1962-67	Battery Tray With Bracket	MSRP \$19.00 ea
1621		1968-74	Battery Tray	MSRP \$19.00 ea
1047E		1962-72	Battery Tray Clamp	MSRP \$5.00 ea

Wholesale Only. MSRP not including Taxes, Shipping and Handling. MSRP are subject to change without notice



1602

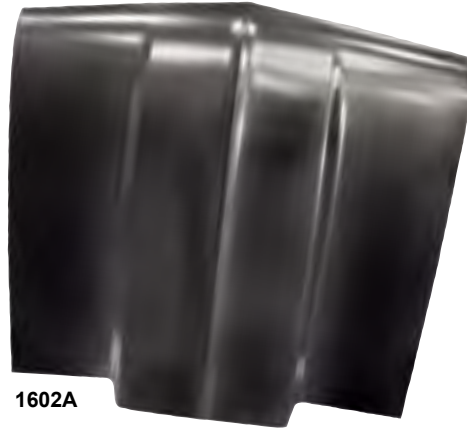

1602A

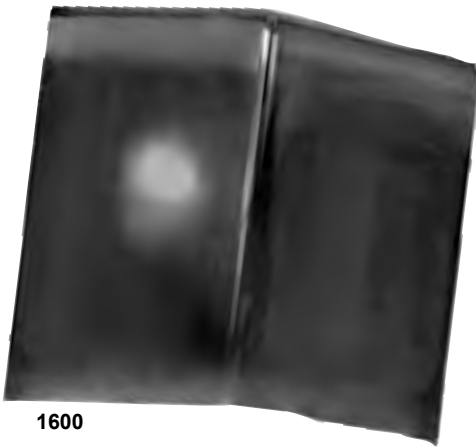

1600

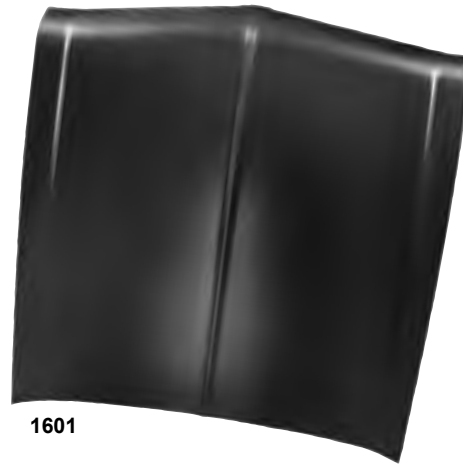

1601



1603

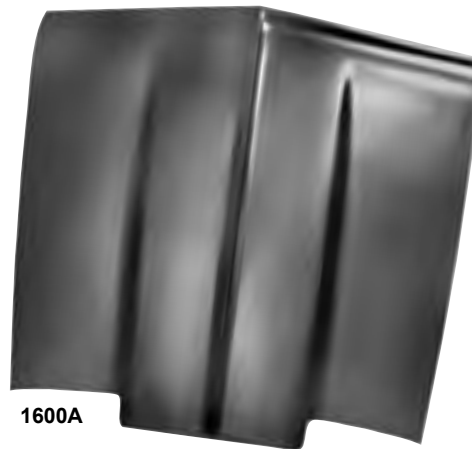

1600A

1602	1962-65	Hood	MSRP \$439.00 ea
1602A	1962-65	Hood with Cowl	MSRP \$650.00 ea
1600	1966-67	Hood	MSRP \$400.00 ea
1600A	1966-67	Hood With Cowl	MSRP \$535.00 ea
1601	1968-72	Hood	MSRP \$509.00 ea
1603	1968-72	Hood With 2 Inch Cowl	MSRP \$725.00 ea
1603A	New 1968-72	Hood With 4 Inch Cowl	MSRP \$745.00 ea

Wholesale Only. MSRP not including Taxes, Shipping and Handling. MSRP are subject to change without notice

Wholesale Only. MSRP not including Taxes, Shipping and Handling. MSRP are subject to change without notice

For "SS" Models



1069F	New	1968-72	Hood Louvers, "ss"
Coming Soon !			
1069H	New	1968-72	Hood Louver Bezel, "ss"
Coming Soon !			
1601A		1968-72	Hood Louver Brackets, "ss"
MSRP \$20.00 pr			

Hood Louvers



1701A	1963-65	Hood Hinge, RH	MSRP \$55.00 ea
1701B	1963-65	Hood Hinge, LH	MSRP \$55.00 ea
1068G	1966-67	Hood Hinge, RH	MSRP \$55.00 ea
1068H	1966-67	Hood Hinge, LH	MSRP \$55.00 ea
1464Y	1968-79	Hood Hinge, RH	MSRP \$60.00 ea
1464Z	1968-79	Hood Hinge, LH	MSRP \$60.00 ea

Hood Hinges

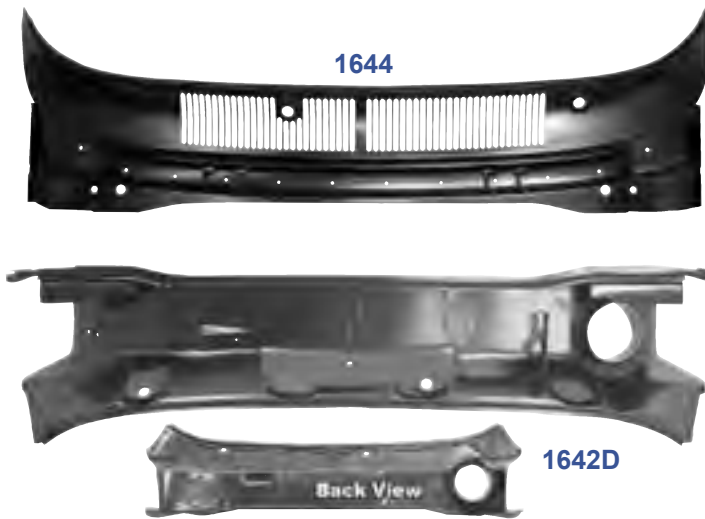

1642



1642A



1642B



1642C



1644	New	1966-67	Cowl Vent Grille	MSRP \$279.00 ea
1642D	New	1966-67	Lower Cowl Grille	MSRP \$285.00 ea
1642		1966-67	Outer Cowl Panel, RH	MSRP \$62.00 ea
1642A		1966-67	Outer Cowl Panel, LH	MSRP \$62.00 ea
1642B	New	1966-67	Cowl Shoulder, RH	MSRP \$132.00 ea
1642C	New	1966-67	Cowl Shoulder, LH	MSRP \$132.00 ea

Cowl Panels

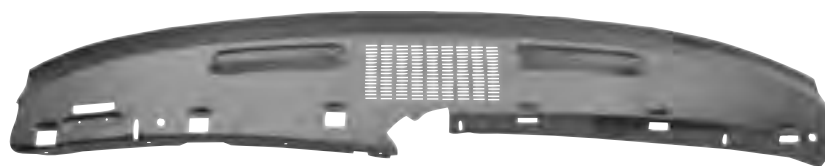

1068E	1968-74	Steel Dash Panel (Will fit with modifications)	MSRP \$92.00 ea
-------	---------	--	------------------------

Dash Panel

Hood Latch Assemblies

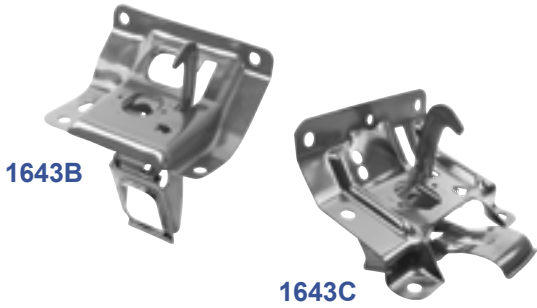

1643B	New	1966	Hood Latch Assembly	MSRP \$107.00 ea
1643C	New	1968-72	Hood Latch Assembly	MSRP \$107.00 ea

Hood Latch Supports

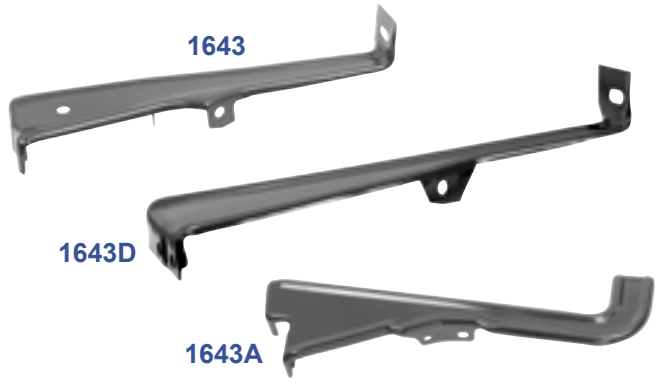

1643	New	1966	Hood Latch Support	MSRP \$42.00 ea
1643D	New	1967	Hood Latch Support	MSRP \$42.00 ea
1643A	New	1968-72	Hood Latch Support	MSRP \$42.00 ea

Pillar Panels



1642F	New	1966-67	Windshield Pillar Panel, RH	MSRP \$35.00 ea
1642G	New	1966-67	Windshield Pillar Panel, LH	MSRP \$35.00 ea
1637	New	1966-67	Quarter "B" Pillar Panel, RH	Coming Soon!
1637A	New	1966-67	Quarter "B" Pillar Panel, LH	Coming Soon!

Engine Mounts

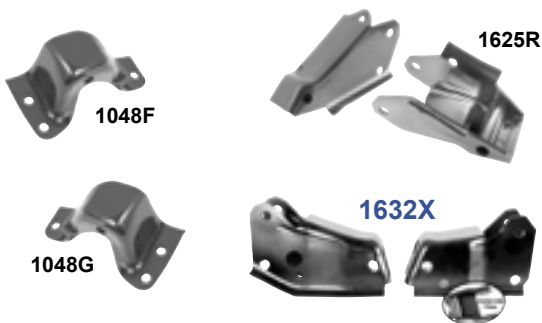

1625R	1966-67	Engine Mounts for 6 cyl.	MSRP \$94.00 pr
1632X	New	1966-67	Engine Mounts for V-8
MSRP \$100.00 pr			
1048F	1968-72	Engine Mount, RH	Small Block V8
1048G	1968-72	Engine Mount, LH	Small Block V8
MSRP \$20.00 ea			

Roof Drip Rails

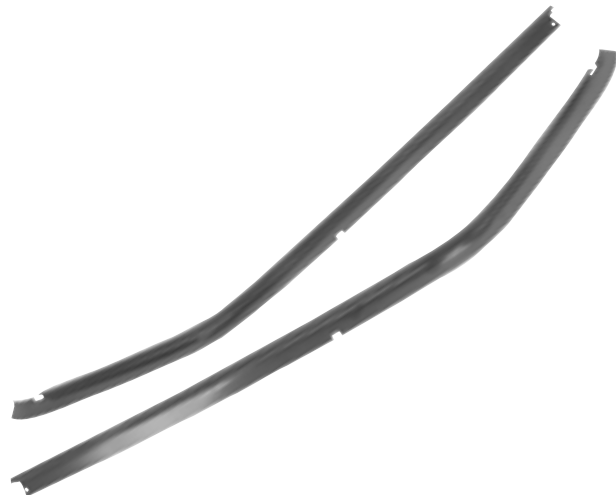

1672	New	1966-67	Roof Drip Rails	MSRP \$149.00 pr
------	-----	---------	-----------------	-------------------------

Wholesale Only. MSRP not including Taxes, Shipping and Handling. MSRP are subject to change without notice

1670

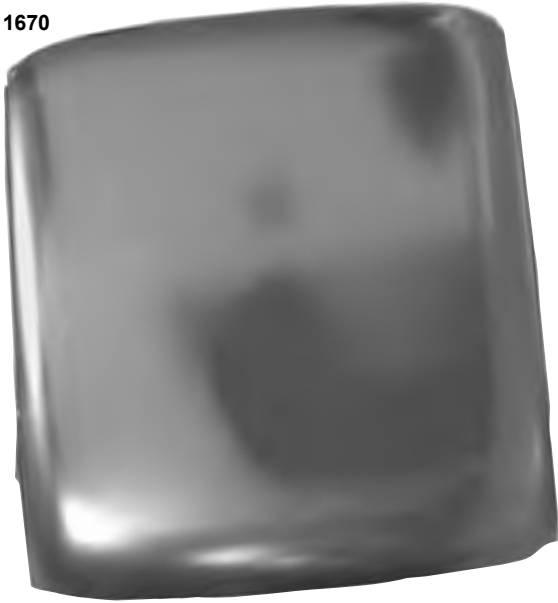

1671

1670	New	1966-67	Roof Panel	MSRP \$535.00 ea
1671	New	1966-67	Inner Roof Panel Brace	MSRP \$269.00 ea

1645

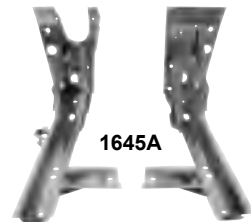

1645A

1645	New	1966-67	Firewall	MSRP \$420.00 ea
1645A	New	1966-67	Firewall to Floor Braces	MSRP \$307.00 pr

1630



1635



1047F

1630		1962-67	Full Floor Pan, RH	MSRP \$80.00 ea
1631		1962-67	Full Floor Pan, LH	

1634		1968-74	Full Floor Pan, RH	MSRP \$80.00 ea
1635		1968-74	Full Floor Pan, LH	

1047F		1962-72	Floor Pan Plug	MSRP \$5.00 ea
-------	--	---------	----------------	----------------



Wholesale Only. MSRP not including Taxes, Shipping and Handling. MSRP are subject to change without notice.

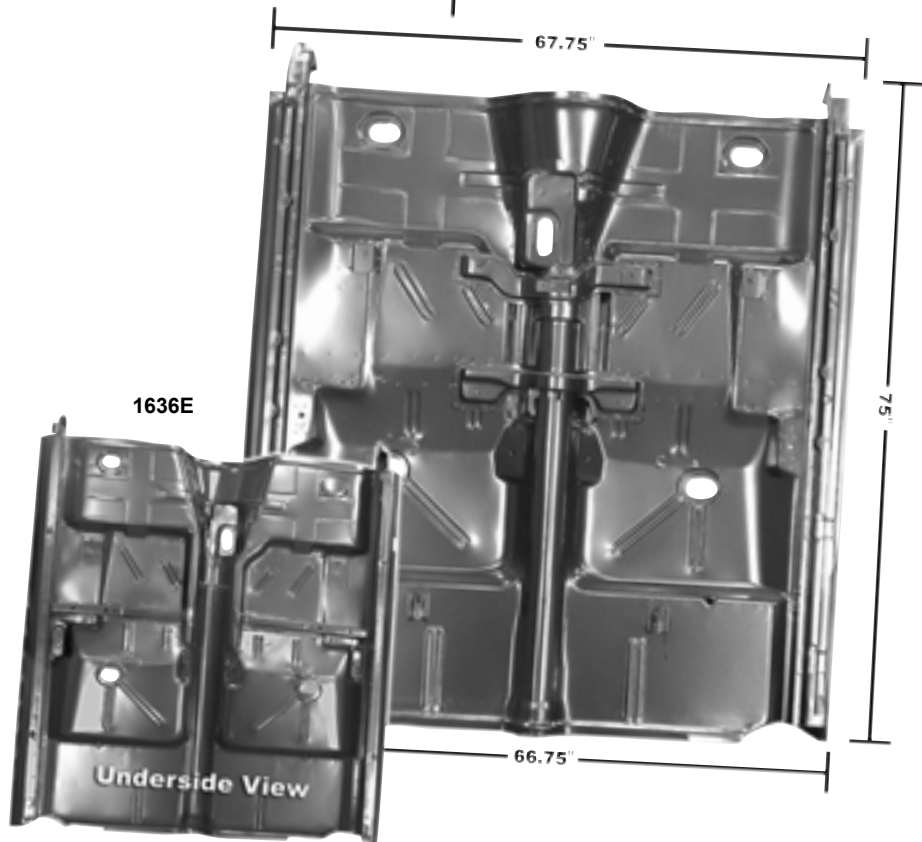
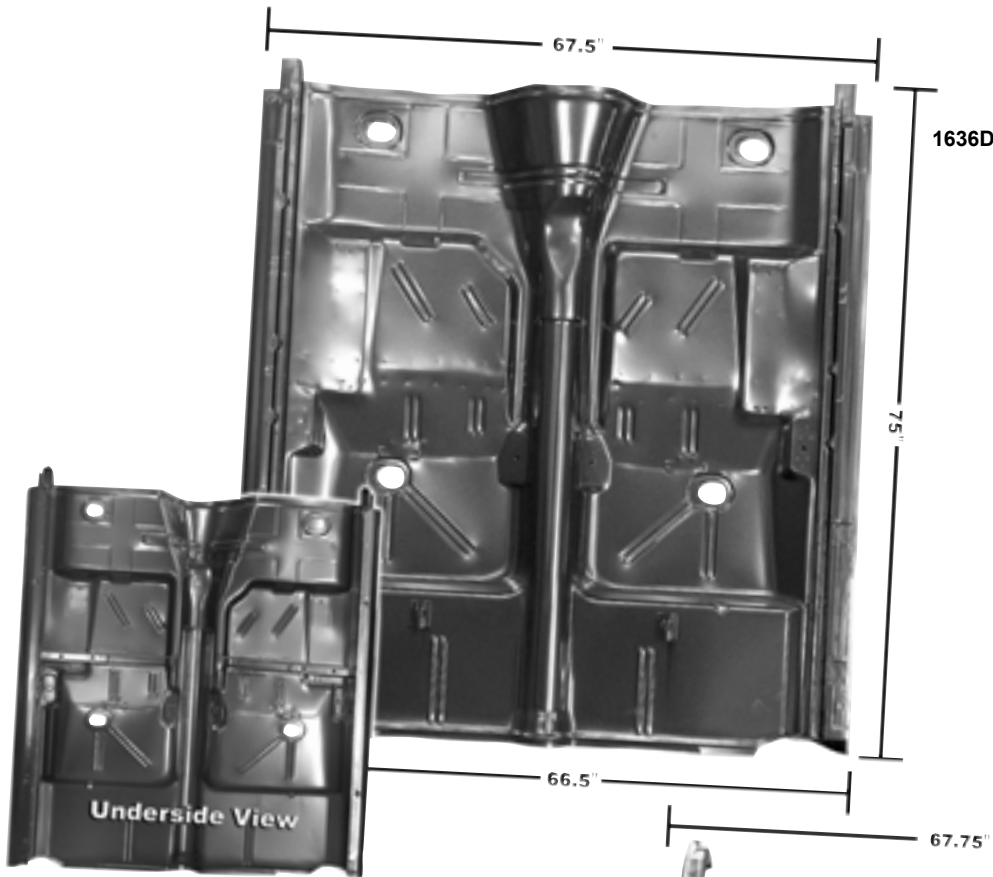

Does Not Qualify For Free Freight Program

1636D	1962-67	Complete Floor Pan w/Rockers & Bucket Seat Mounts, Automatic Transmission	MSRP \$1300.00 ea
1636E	1962-67	Complete Floor Pan w/Rockers (No holes/seat mounts), Manual Transmission	MSRP \$1300.00 ea

Wholesale Only. MSRP not including Taxes, Shipping and Handling. MSRP are subject to change without notice



1636 1962-67 Complete Floor Pan, For Automatic Transmission MSRP \$549.00 ea

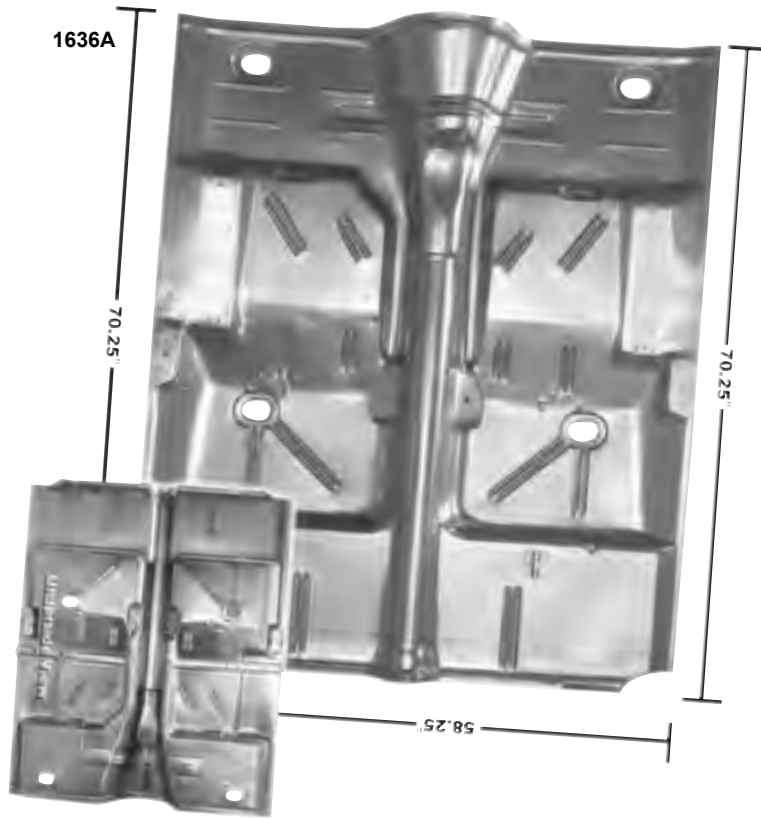
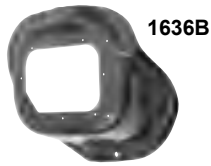

1636A 1962-67 Complete Floor Pan (no hole) MSRP \$477.00 ea
 1636B 1962-67 Floor Cover, For Manual Transmission MSRP \$45.00 ea

Wholesale Only. MSRP not including Taxes, Shipping and Handling. MSRP are subject to change without notice

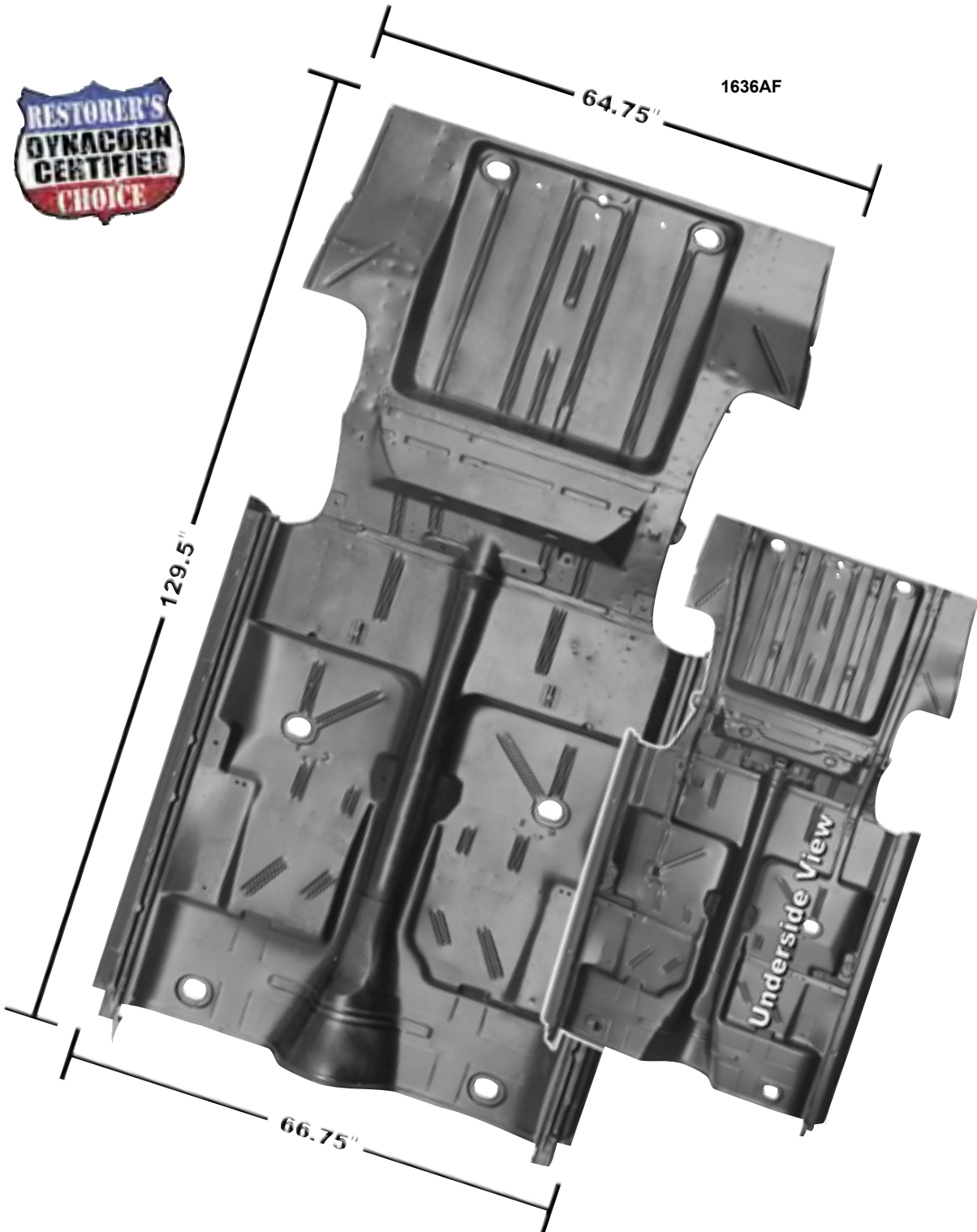

***Does Not Qualify For Free Freight Program
* non stocking item- Call for availability ****

1636AF	1966-67	Complete Floor & Trunk Pan	MSRP \$3250.00 ea
1636AE	New 1966-67	Complete Floor & Trunk Pan with Rocker Panels	MSRP \$3450.00 ea

Wholesale Only. MSRP not including Taxes, Shipping and Handling. MSRP are subject to change without notice

Wholesale Only. MSRP not including Taxes, Shipping and Handling. MSRP are subject to change without notice



1625P New 1966-67 Transmission Mount Crossmember
MSRP \$97.00 ea

Trans. Mount Crossmember

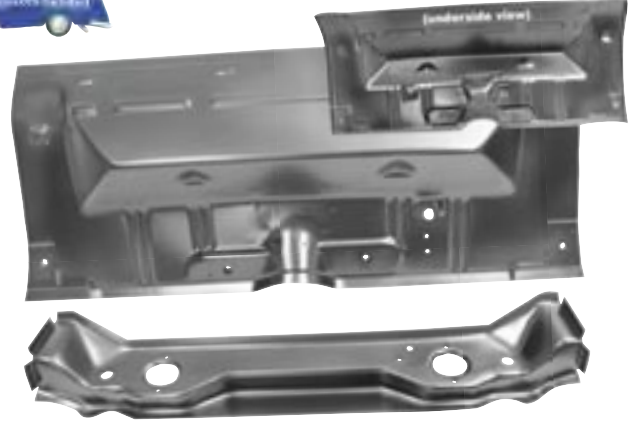

1632B 1962-67 Rear Seat Floor Pan w/braces
MSRP \$344.00 ea

Rear Seat Floor Pan

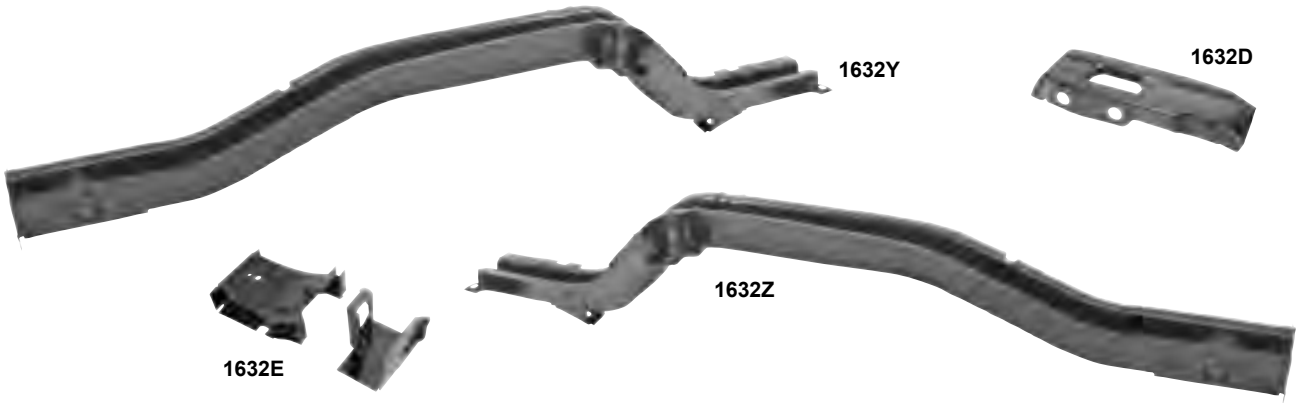

1632Y	1966-67	Frame Rail, RH	MSRP \$317.00 ea
1632Z	1966-67	Frame Rail, LH	MSRP \$317.00 ea
1632E	1966-67	Front Frame Rail Brace, RH	MSRP \$49.00 ea
1632F	1966-67	Front Frame Rail Brace, LH	MSRP \$49.00 ea
1632C	1966-67	Rear Frame Rail Brace, RH	MSRP \$25.00 ea
1632D	1966-67	Rear Frame Rail Brace, LH	MSRP \$25.00 ea

Frame Rails & Braces



1660	1966-67	Rocker Panel, RH	MSRP \$324.00 ea
1661	1966-67	Rocker Panel, LH	MSRP \$324.00 ea

Rocker Panels

Seat Frame Supports



1636C 1962-67 Seat Frame Supports, 4 pcs.
MSRP \$150.00 set

Seat Track Assy.

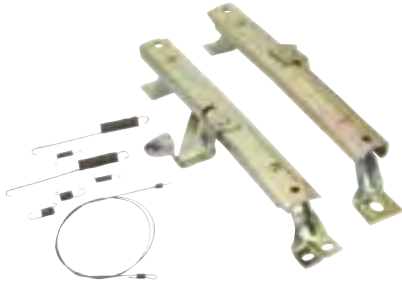

1632J New 1966-67 Bench Seat Track Assembly
MSRP \$152.00 set

Seat Frame Assembly

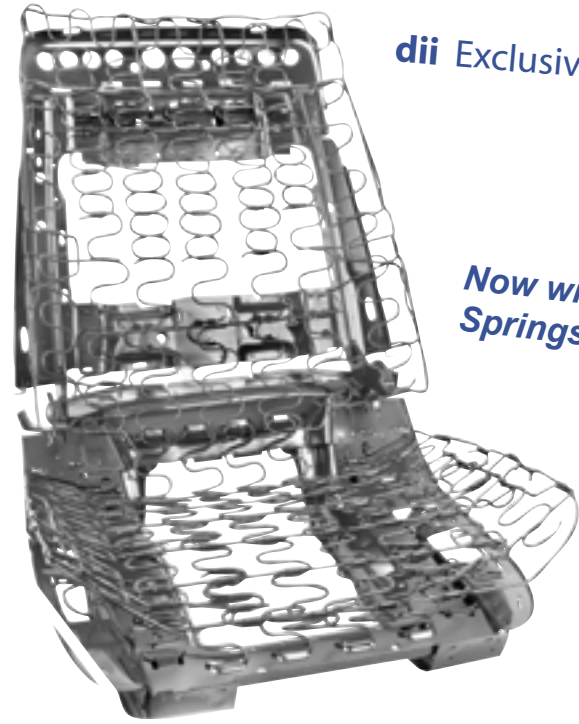

dii Exclusive

Now with Springs!

1402A 1969-72 Seat Frame Assembly
MSRP \$509.00 ea

Quarter/Door Frame Assembly

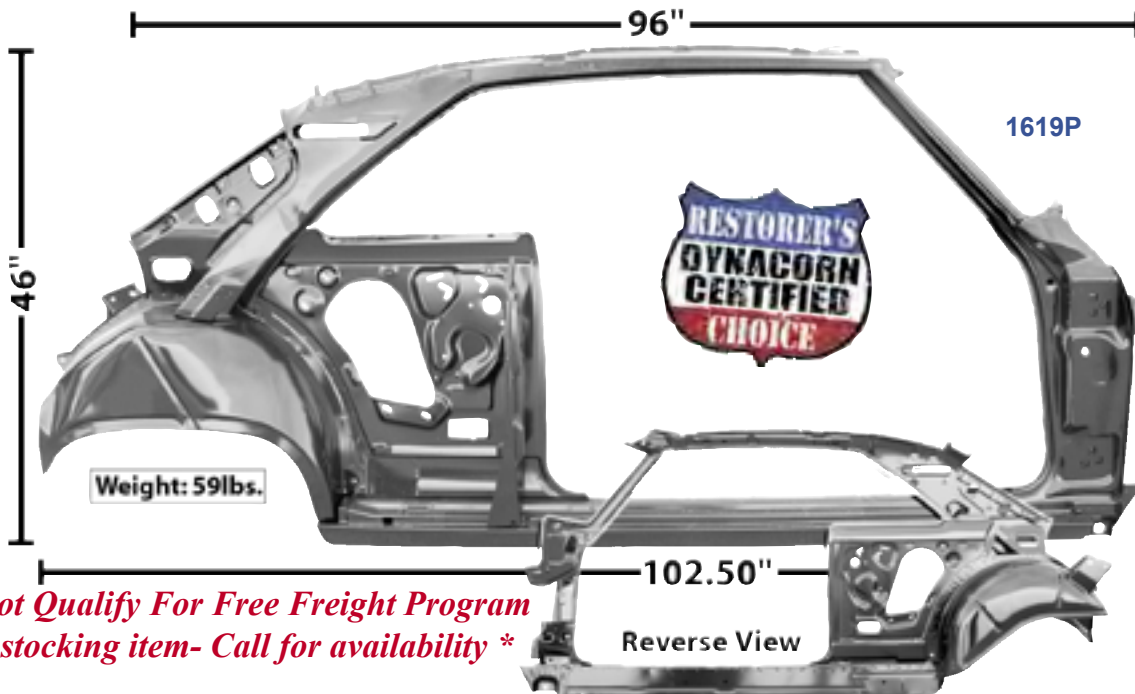

Does Not Qualify For Free Freight Program
** non stocking item- Call for availability **

Reverse View

1619P	New	1966-67	Quarter/Door Frame Assembly, RH	MSRP \$1530.00 ea
1619Q	New	1966-67	Quarter/Door Frame Assembly, LH	MSRP \$1530.00 ea

Wholesale Only. MSRP not including Taxes, Shipping and Handling. MSRP are subject to change without notice



Wholesale Only. MSRP not including Taxes, Shipping and Handling. MSRP are subject to change without notice

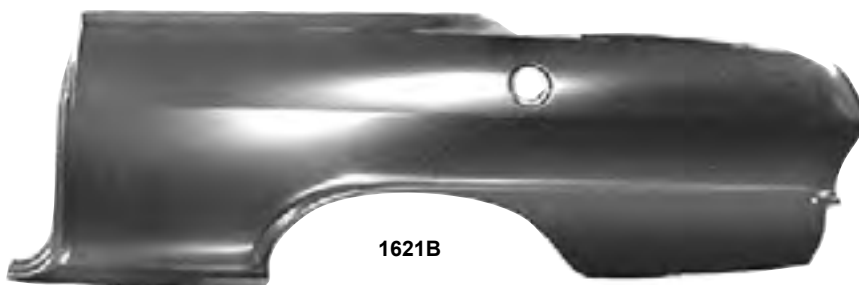

1621B



1621X

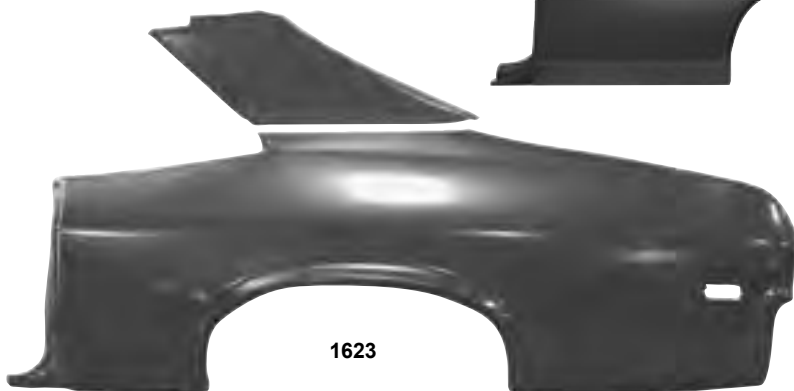

1623



1623B

1621A	1962-65	Full Quarter Panel, RH	MSRP \$362.00 ea
1621B	1962-65	Full Quarter Panel, LH	MSRP \$362.00 ea
1621W	1966-67	Full Quarter Panel With Sail, RH	MSRP \$547.00 ea
1621X	1966-67	Full Quarter Panel With Sail, LH	MSRP \$547.00 ea
1622	1968-69	Full Quarter Panel With Sail, RH	MSRP \$515.00 ea
1623	1968-69	Full Quarter Panel With Sail, LH	MSRP \$515.00 ea
1623A	1970-72	Full Quarter Panel With Sail, RH	MSRP \$515.00 ea
1623B	1970-72	Full Quarter Panel With Sail, LH	MSRP \$515.00 ea

Quarter Panel Skins



1623F	1968-69	Quarter Panel Skin, RH	MSRP \$190.00 ea
1623G	1968-69	Quarter Panel Skin, LH	MSRP \$190.00 ea
1623H	1970-72	Quarter Panel Skin, RH	MSRP \$190.00 ea
1623J	1970-72	Quarter Panel Skin, LH	MSRP \$190.00 ea



Wheelhouses

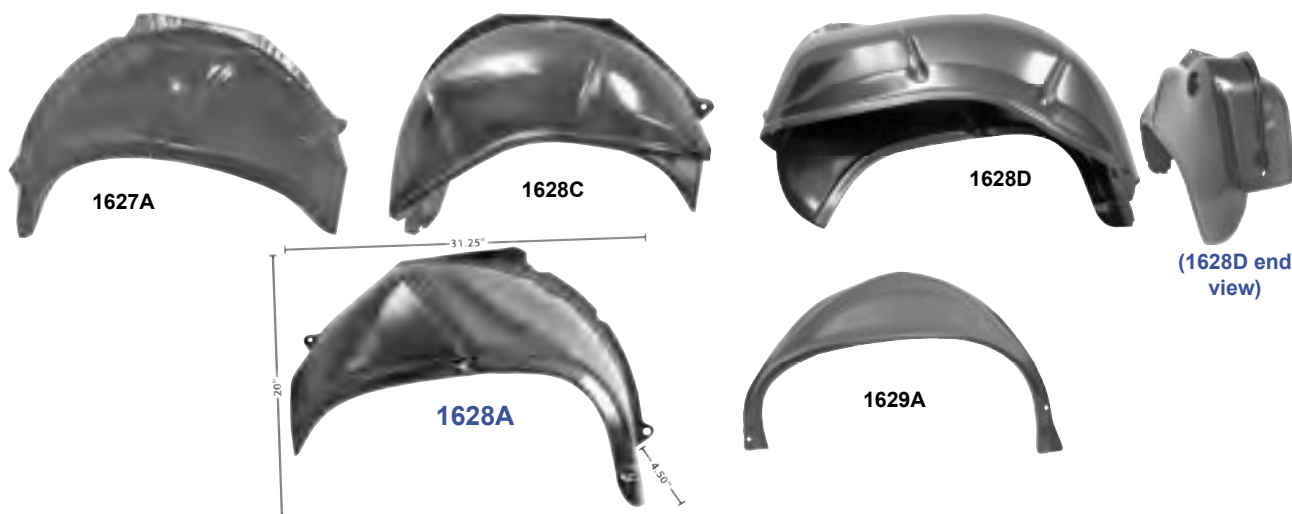

1627A	1962-65	Outer Wheelhouse, RH	MSRP \$90.00 ea
1627B	1962-65	Outer Wheelhouse, LH	MSRP \$90.00 ea
1628C	1966-67	Complete Wheelhouse (Inner & Outer), RH	MSRP \$244.00 ea
1628D	1966-67	Complete Wheelhouse (Inner & Outer), LH	MSRP \$244.00 ea
1628A	1966-67	Outer Wheelhouse, RH	MSRP \$102.00 ea
1628B	1966-67	Outer Wheelhouse, LH	MSRP \$102.00 ea
1629A	1968-74	Outer Wheelhouse, RH	MSRP \$125.00 ea
1629B	1968-74	Outer Wheelhouse, LH	MSRP \$125.00 ea

Deck Filler Panel



1615	1966-67	Deck Lid Filler Panel	MSRP \$92.00 ea
1615E	New 1968-72	Deck Lid Filler Panel	MSRP \$112.00 ea

Rear Body Panels

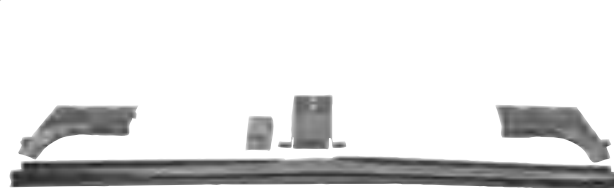

1623Z	1966-67	Rear Body Panel	MSRP \$124.00 set
-------	---------	-----------------	--------------------------

Wholesale Only. MSRP not including Taxes, Shipping and Handling. MSRP are subject to change without notice

Wholesale Only. MSRP not including Taxes, Shipping and Handling. MSRP are subject to change without notice.

Tail Lamp Panels



1623Y	1966-67	Complete Tail Lamp Panel	MSRP \$420.00 ea
-------	---------	--------------------------	------------------



1624	1968-69	Tail Lamp Panel	MSRP \$149.00 ea
------	---------	-----------------	------------------

1625	1970-72	Tail Lamp Panel	MSRP \$149.00 ea
------	---------	-----------------	------------------

Tail Lamp Mounting Panels

1621D



1621C



1621V



1621U



1621C	1962-64 1965	Tail Lamp Mounting Panel, RH 2 door (With Modifications)	MSRP \$69.00 ea
-------	-----------------	---	-----------------

1621D	1962-64 1965	Tail Lamp Mounting Panel, LH 2 door (With Modifications)	MSRP \$69.00 ea
-------	-----------------	---	-----------------

1621U	1966-67	Tail Lamp Mounting Panel, RH	MSRP \$69.00 ea
-------	---------	------------------------------	-----------------

1621V	1966-67	Tail Lamp Mounting Panel, LH	MSRP \$69.00 ea
-------	---------	------------------------------	-----------------

Lic. Plate Brkt.

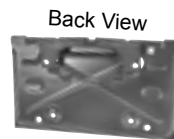

1078A	1970-74	License Plate Bracket	MSRP \$34.00 ea
-------	---------	-----------------------	-----------------



T27



T27A

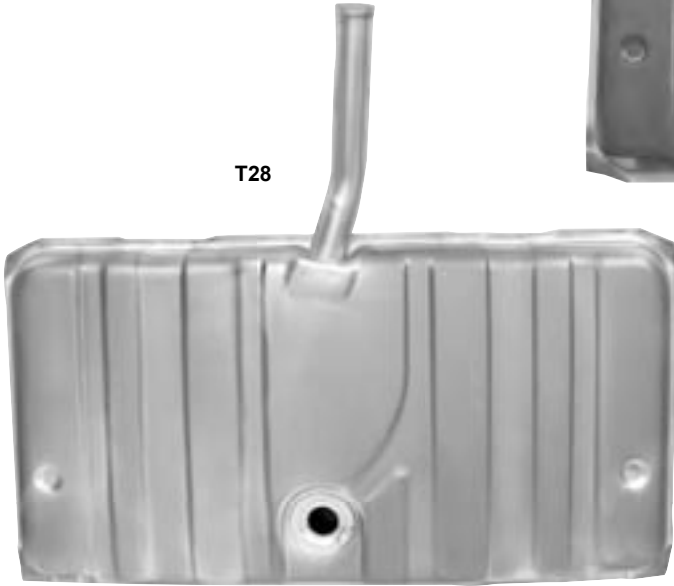

T28

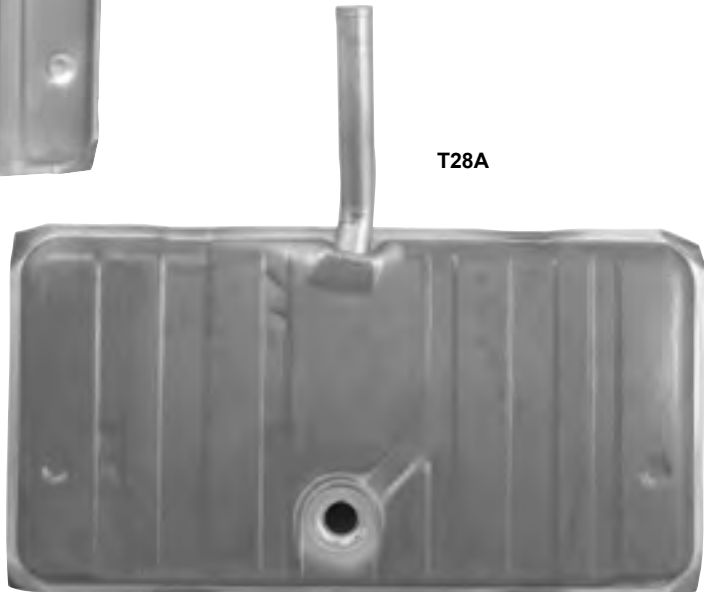

T28A

T27	1962-67	Fuel Tank	MSRP \$152.00 ea
T27A	1968-69	Fuel Tank	MSRP \$152.00 ea
T28	1970-72	Fuel Tank with E.E.C.	MSRP \$152.00 ea
T28A	1971-72	Fuel Tank without E.E.C.	MSRP \$152.00 ea

Wholesale Only. MSRP not including Taxes, Shipping and Handling. MSRP are subject to change without notice

Wholesale Only. MSRP not including Taxes, Shipping and Handling. MSRP are subject to change without notice

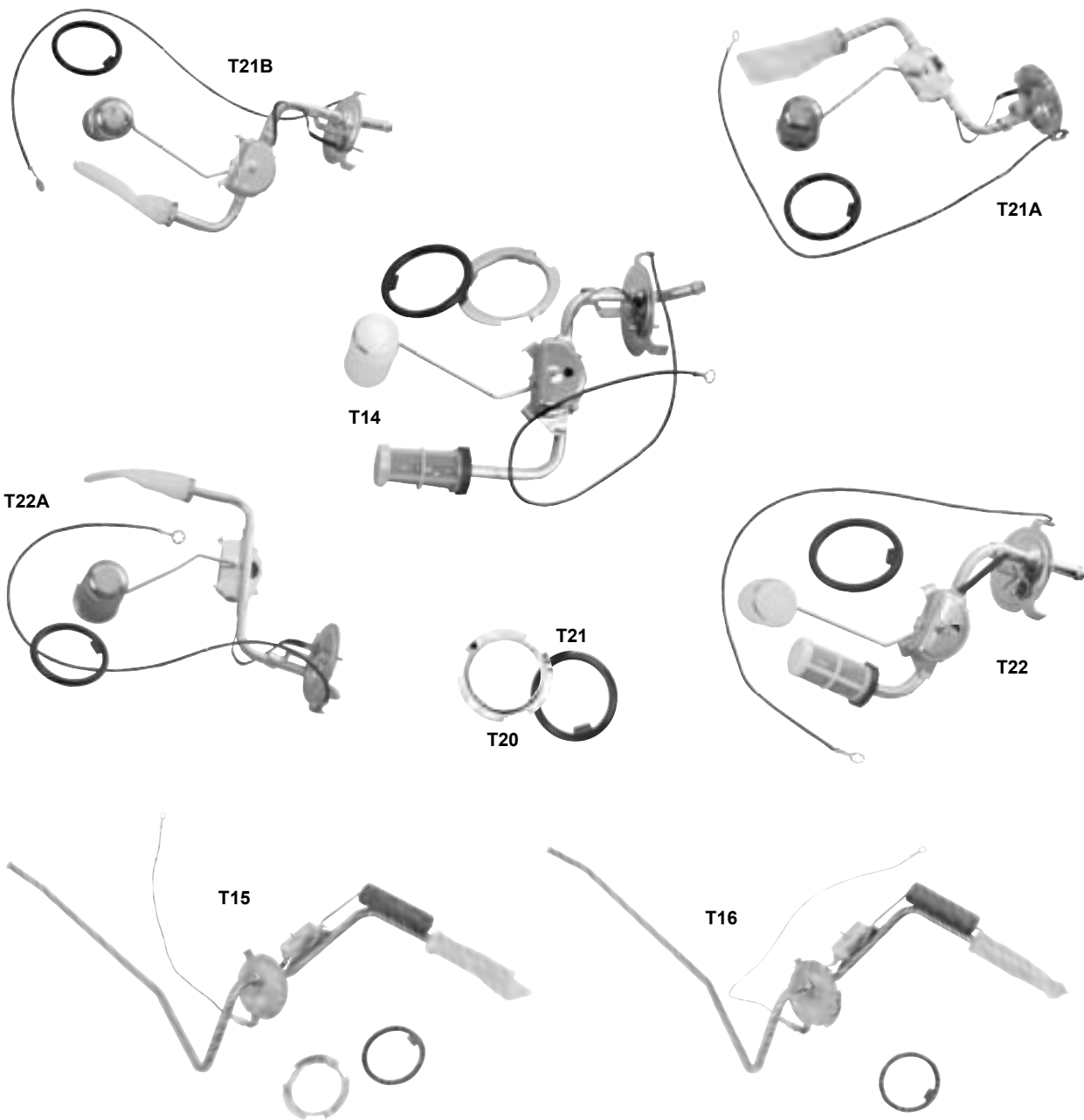

T21A	1962-65	Fuel Sending Unit, 5/16" (Except 4 BBL)	MSRP \$49.00 ea
T21B	1964-65	Fuel Sending Unit, 3/8"	MSRP \$49.00 ea
T22A	1966-67	Fuel Sending Unit, 5/16"	MSRP \$49.00 ea
T14	1966-67	Fuel Sending Unit, 2 BBL (Locking ring included)	MSRP \$55.00 ea
T22	1966-67	Fuel Sending Unit, 4 BBL (M04)	MSRP \$65.00 ea
T15	1968-69	Fuel Sending Unit, 5/16", 6 cylinder (Locking ring included)	MSRP \$57.00 ea
T16	1968	Fuel Sending Unit, 3/8", V8	MSRP \$57.00 ea
	1969	3/8", V8 & 2 BBL, 396	
T20	1962-74	Fuel Sending Unit Locking Ring	MSRP \$4.00 ea
T21	1962-74	Fuel Sending Unit Gasket	MSRP \$4.00 ea

Fuel Tank Straps



T28B New 1968-72 Fuel Tank Straps
MSRP \$34.00 pr

Gas Caps



1623K



1623L

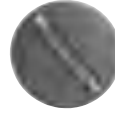

1623N

1623K	1962-64	Gas Cap, Chrome
1623L	1962-64	Gas Cap, Black
MSRP \$25.00 ea		

1623M	1965-67	Gas Cap, Chrome
1623N	1965-67	Gas Cap, Black
MSRP \$25.00 ea		

Trunk Lids



1604



1605

1604	New	1966-67	Trunk Lid	MSRP \$515.00 ea
1605		1968-74	Trunk Lid (Except Hatchback)	MSRP \$239.00 ea

Wholesale Only. MSRP not including Taxes, Shipping and Handling. MSRP are subject to change without notice

Wholesale Only. MSRP not including Taxes, Shipping and Handling. MSRP are subject to change without notice



Trunk Hinges

1604B New 1966-67 Trunk Lid Hinges
MSRP \$170.00 pr



Trunk Lid Rubber Seal

1604A New 1966-67 Trunk Lid Rubber Seal
MSRP \$29.00 ea

M1019



M1019A



Trunk Latches

M1019 1962-70 Trunk Latch
MSRP \$35.00 ea

M1019A 1971-74 Trunk Latch
MSRP \$45.00 ea

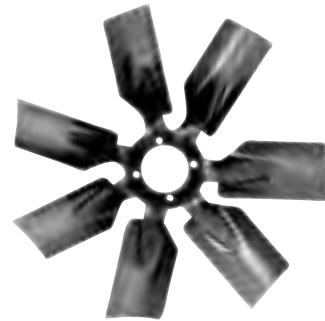

Fan

M1017 1968-72 Fan, 7 blade
MSRP \$92.00 ea

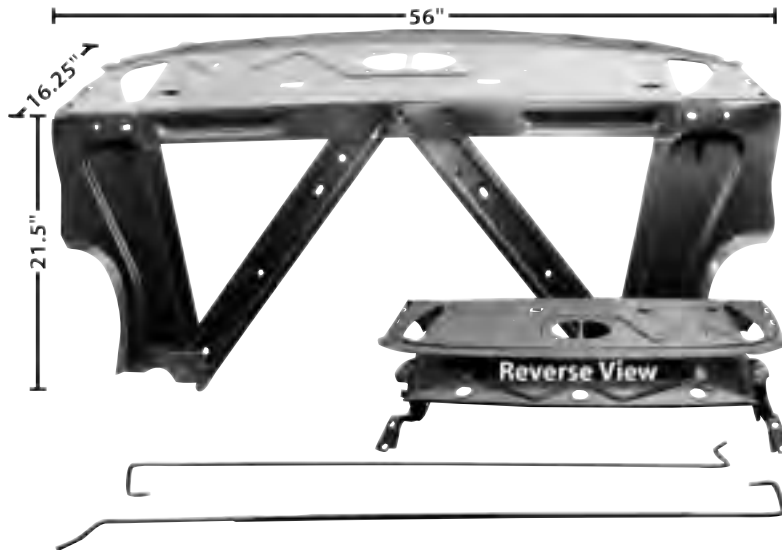

Includes:
 Deck Lid
 Hinges &
 Torsion
 Bars.

Trunk Divider / Package Shelf

1632H New 1966-67 Trunk Divider/Package Shelf

MSRP \$630.00 ea

Trunk Floor Pans



1632A	1962-67	Complete Trunk Floor Pan With Straps	MSRP \$535.00 ea
1632G	1966-67	Complete Trunk Floor Pan W/Rear Seat Pan & Frame Rails	MSRP \$1725.00 ea
1632	1962-67	Trunk Floor Pan	MSRP \$80.00 ea
1633	1968-74	Trunk Floor Pan	MSRP \$80.00 ea

Trunk Floor Drop Offs



1633A	1966-67	Trunk Floor Drop Off, RH	MSRP \$57.00 ea
1633B	1966-67	Trunk Floor Drop Off, LH	MSRP \$57.00 ea

Wholesale Only. MSRP not including Taxes, Shipping and Handling. MSRP are subject to change without notice



Wholesale Only. MSRP not including Taxes, Shipping and Handling. MSRP are subject to change without notice

1619J

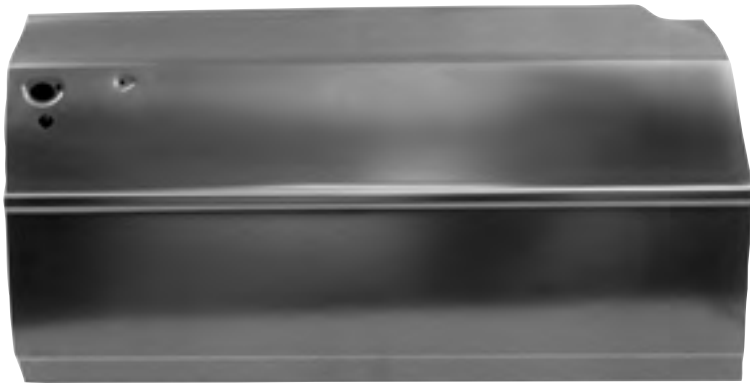

1619L

1619J	1966	Door Shell, RH	MSRP \$575.00 ea
1619K	1966	Door Shell, LH	MSRP \$575.00 ea
1619L	1967	Door Shell, RH	MSRP \$575.00 ea
1619M	1967	Door Shell, LH	MSRP \$575.00 ea

Door Shells

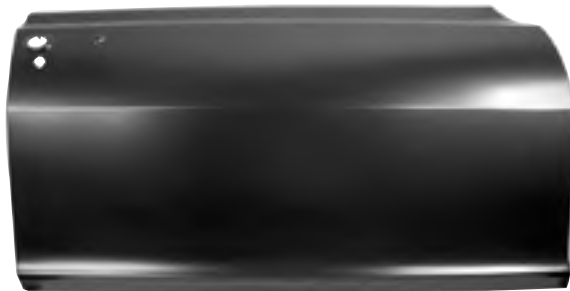

1621N



1621J



1623C

1621N	1962-65	Door Skin, RH	MSRP \$202.00 ea
1621M	1962-65	Door Skin, LH	MSRP \$202.00 ea
1621J	1966-67	Door Skin, RH	MSRP \$190.00 ea
1621K	1966-67	Door Skin, LH	MSRP \$190.00 ea
1623C	1968-72	Door Skin, RH	MSRP \$190.00 ea
1623D	1968-72	Door Skin, LH	MSRP \$190.00 ea

Door Skins

Door Window Tracks

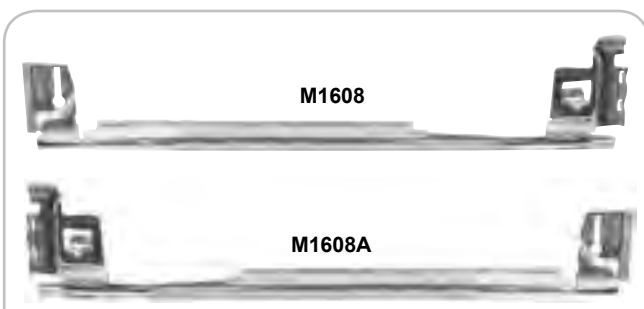

M1608 1962-65 Lower Window Track, RH
 M1608A 1962-65 Lower Window Track, LH

MSRP \$69.00 ea

Interior Door Handles

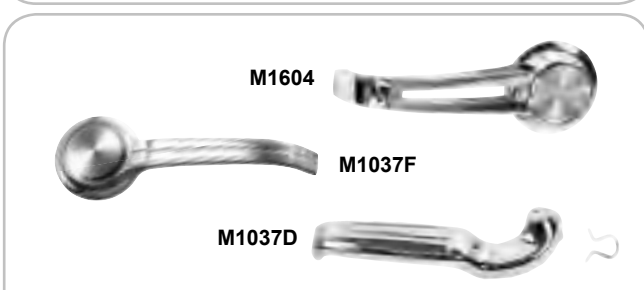

M1604 1962-64 Interior Door Handle, Double Arm
MSRP \$14.00 ea

M1037F 1965-67 Interior Door Handle, Std., Single Arm
MSRP \$14.00 ea

M1037D 1968-74 Interior Door Handle, RH Standard
 M1037E 1968-74 Interior Door Handle, LH Standard

MSRP \$22.00 ea

Exterior Door Handles



M1600 1962-65 Exterior Door Handles
MSRP \$62.00 pr

M1601A 1962-65 Exterior Door Handle Push Button Kit
MSRP \$10.00 kit

M1600A 1966-67 Exterior Door Handles
MSRP \$62.00 pr

M1602B 1966-67 Exterior Door Handle Push Button Kit
MSRP \$10.00 kit

M1601 1968-79 Exterior Door Handles
MSRP \$62.00 pr

M1037C 1968-79 Exterior Door Handle Push Button Kit
MSRP \$10.00 kit

Window Cranks



M1392A	1962-64	Chevy II/Nova SS, Double Arm, Black Knob	MSRP \$14.00 ea
	1967	Nova	
M1392B	1964	Chevy II/Nova, Double Arm, Chrome Knob	MSRP \$15.00 ea
M1392C	1964	Chevy II/Nova, Single Arm, Black Knob	MSRP \$14.00 ea
M1392D	1964	Chevy II/Nova, Single Arm, Black Knob w/Chrome Button	MSRP \$14.00 ea
M1776	1965-66	Nova, Black Knob	MSRP \$25.00 ea
M1382A	1967	Nova, Black Knob	MSRP \$25.00 ea
M1037A	1968	Nova, Black Knob	MSRP \$5.00 ea
M1037B	1969-70	Nova, Clear Knob	MSRP \$5.00 ea

Wholesale Only. MSRP not including Taxes, Shipping and Handling. MSRP are subject to change without notice

Wholesale Only. MSRP not including Taxes, Shipping and Handling. MSRP are subject to change without notice



M1392N 1967 Vent Window Crank
MSRP \$17.00 ea

Vent Crank



1076FA

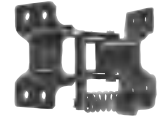

1076FD

1076FA	New	1969-79	Upper RH
1076FB	New	1969-79	Upper LH
MSRP \$62.00 ea			
1076FC	New	1969-79	Lower RH
1076FD	New	1969-79	Lower LH
MSRP \$62.00 ea			

Door Hinges

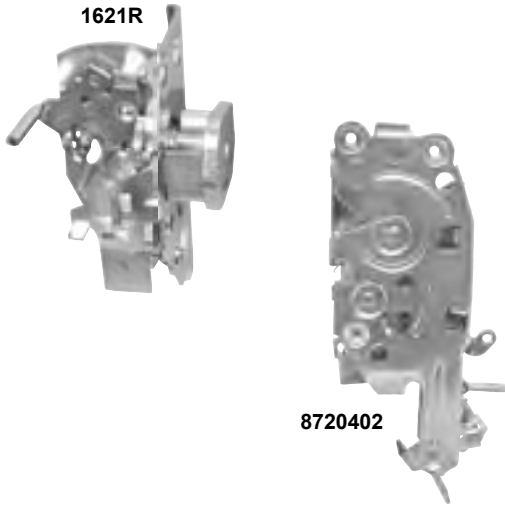

1621R	1966-67	Door Latch, RH	(1963-65 With modification)
1621S	1966-67	Door Latch, LH	(1963-65 With modification)
MSRP \$87.00 ea			
8720401	1969-70	Door Latch, RH	
8720402	1969-70	Door Latch, LH	
MSRP \$69.00 ea			

Door Latches



1623E 1968-72 Door Hinge Rollers
MSRP \$14.00 pr

Hinge Roller

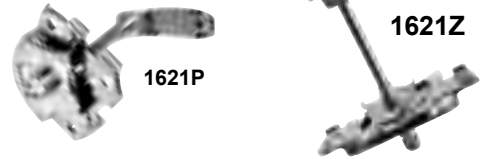

1621P	1966	Door Latch Relay, RH	(1962-65 w/ modification)
1621Q	1966	Door Latch Relay, LH	(1962-65 w/ modification)
MSRP \$35.00 ea			
1621Y	1967	Door Latch Relay, RH	
1621Z	1967	Door Latch Relay, LH	
MSRP \$37.00 ea			

Door Latch Relays

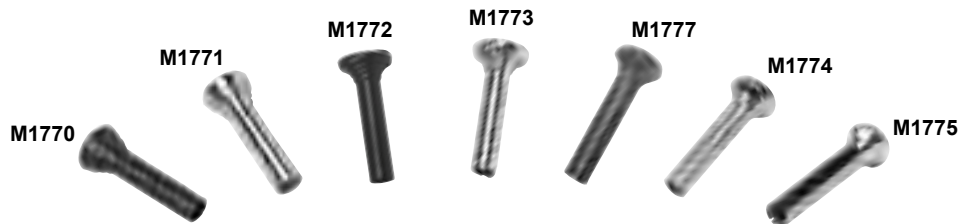

M1770	1962-66	Door Lock Knobs, Black	MSRP \$5.00 pr
M1771	1962-66	Door Lock Knobs, Chrome	MSRP \$5.00 pr
M1772	1967	Door Lock Knobs, Black	MSRP \$5.00 pr
M1773	1967	Door Lock Knobs, Chrome	MSRP \$5.00 pr
M1777	1968	Door Lock Knobs, Grooved Black	MSRP \$5.00 pr
M1774	1969-70	Door Lock Knobs, Grooved Chrome	MSRP \$5.00 pr
M1775	1970-76	Door Lock Knobs, Chrome	MSRP \$5.00 pr

Door Lock Knobs

Front Arm Rest Bases

M1602



M1603



M1040A



M1040C



M1040B



M1602	1962-64	Arm Rest Bases, Front, Chrome	MSRP \$34.00 pr
M1603	1966-67	Arm Rest Bases, Front, Chrome	MSRP \$30.00 pr
M1040	1968-72	Arm Rest Base, Black RH	MSRP \$17.00 ea
M1040A	1968-72	Arm Rest Base, Black LH	MSRP \$17.00 ea
M1040B	1968-72	Arm Rest Bases, Red	MSRP \$37.00 pr
M1040C	1968-72	Arm Rest Bases, Medium Blue	MSRP \$37.00 pr
M1040D	1968-72	Arm Rest Bases, Ivy Gold	MSRP \$37.00 pr
M1040E	1968-72	Arm Rest Bases, White	MSRP \$37.00 pr
M1040F	1968-72	Arm Rest Bases, Dark Blue	MSRP \$37.00 pr
M1040G	1968-72	Arm Rest Bases, Dark Green	MSRP \$37.00 pr

Emblems

3953840



3874540



3940538

3953676



4539568



7790751

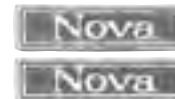

4883156



4226981



M1635
GM Restoration Parts



3793606



8728940



3953840	1969-72	Hood Lip Emblem, "bowtie"	MSRP \$64.00 ea
3874540	1966	Grille Emblem, "Chevy II"	MSRP \$54.00 ea
3918871	1968-69	Grille Emblem, "SS"	MSRP \$27.00 ea
3940538	1970-72	Grille Emblem, "SS"	MSRP \$54.00 ea
3953676	1968-72	Front Fender Emblem, "Nova"	MSRP \$37.00 ea
4539568	1966-67	Door Panel Emblems, "Chevy II"	MSRP \$49.00 ea
7790751	1969-72	Door Panel Emblems, "Nova"	MSRP \$49.00 ea
4883156	1963-64	Quarter Panel Emblem, "Nova SS"	MSRP \$54.00 ea
4226981	1966-67	Quarter Panel Emblem, "Nova Chevy II" std	MSRP \$89.00 ea
M1635	1968-72	Rear Trim Emblem, "SS"	MSRP \$40.00 ea
3793606	1963-64	Trunk Lid Emblem, "Nova SS"	MSRP \$54.00 ea
8728940	1968-72	Trunk Lid Emblem, "Nova by Chevrolet"	MSRP \$35.00 ea

Wholesale Only. MSRP not including Taxes, Shipping and Handling. MSRP are subject to change without notice

Wholesale Only. MSRP not including Taxes, Shipping and Handling. MSRP are subject to change without notice.

3790349

M1016

M1616A

3790350

M1616A	1962	Grille, Standard	Coming Soon!
M1016	1962-75	Headlamp Retaining Ring	MSRP \$9.00 ea
3790350	1962-64	Headlamp Bezel, RH	MSRP \$90.00 ea
3790349	1962-64	Headlamp Bezel, LH	MSRP \$90.00 ea

3790349

M1016

M1616B

3790350

M1616B	1963	Grille, Standard	Coming Soon!
M1016	1962-75	Headlamp Retaining Ring	MSRP \$9.00 ea
3790350	1962-64	Headlamp Bezel, RH	MSRP \$90.00 ea
3790349	1962-64	Headlamp Bezel, LH	MSRP \$90.00 ea

3790349

M1016

M1616C

3790350

M1616C	1964	Grille, Standard	Coming Soon!
M1016	1962-75	Headlamp Retaining Ring	MSRP \$9.00 ea
3790350	1962-64	Headlamp Bezel, RH	MSRP \$90.00 ea
3790349	1962-64	Headlamp Bezel, LH	MSRP \$90.00 ea

M1016

M1616D

M1616D	1965	Grille, Standard	Coming Soon!
M1016	1962-75	Headlamp Retaining Ring	MSRP \$9.00 ea

Wholesale Only. MSRP not including Taxes, Shipping and Handling. MSRP are subject to change without notice.

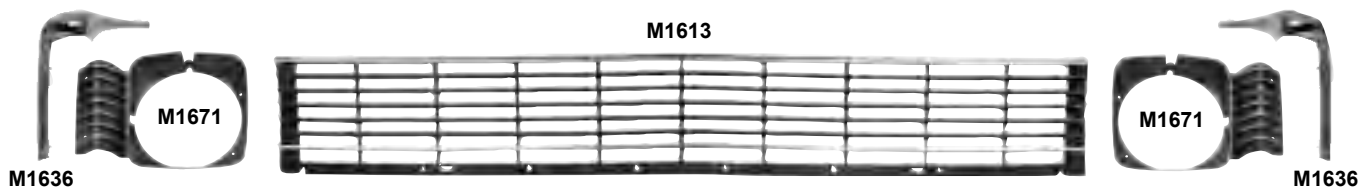
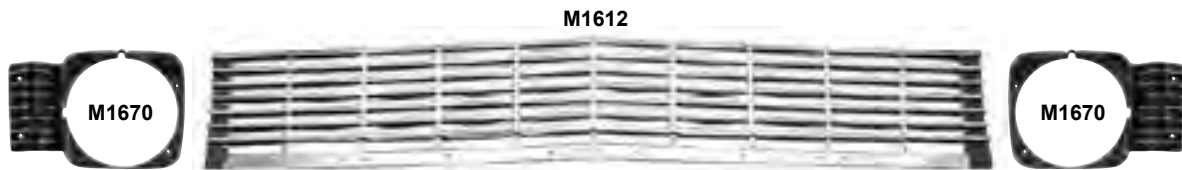

M1612	1968-69	Grille, Standard	MSRP \$170.00 ea
M1613	1968-69	Grille, "ss"	MSRP \$170.00 ea
M1016	1962-75	Headlamp Retaining Ring	MSRP \$9.00 ea
M1670	1968	Headlamp Bezels	MSRP \$112.00 pr
M1671	1969-72	Headlamp Bezels	MSRP \$112.00 pr
M1636	1968-72	Eyebrow Moldings	MSRP \$99.00 pr

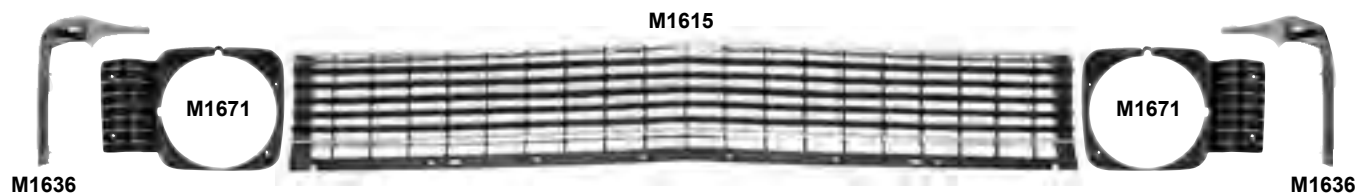

M1614	1970-72	Grille, Standard	MSRP \$170.00 ea
M1615	1970-72	Grille, "ss"	MSRP \$170.00 ea
M1016	1962-75	Headlamp Retaining Ring	MSRP \$9.00 ea
M1671	1969-72	Headlamp Bezels	MSRP \$112.00 pr
M1636	1968-72	Eyebrow Moldings	MSRP \$99.00 pr

Hood Moldings & Spear



M1632	1966	Hood Molding
MSRP \$59.00 ea		
M1630A	1967	Hood Molding
MSRP \$59.00 ea		



M1630	1968-72	Hood Molding
MSRP \$72.00 ea		
M1630B	1973-74	Hood Molding
MSRP \$92.00 ea		

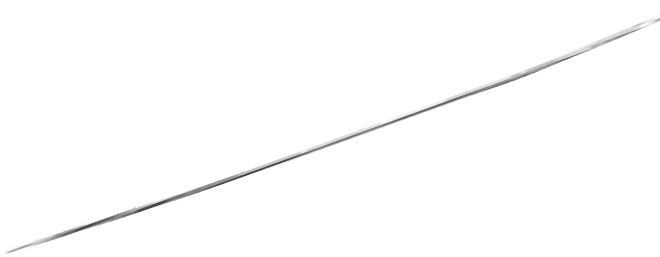

M1631	1962-64	Hood Spear
MSRP \$164.00 ea		

Valance Molding



M1675	1966	Valance Panel Molding
MSRP \$75.00 ea		

Wheel Opening Moldings

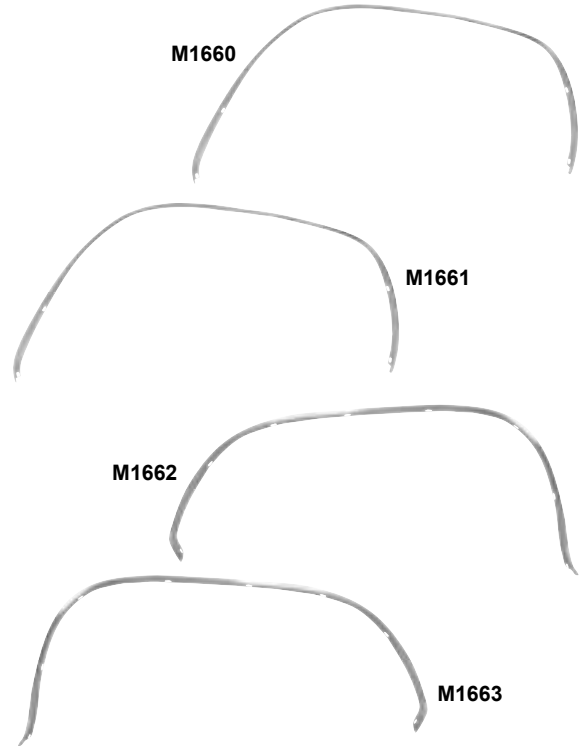

M1659A	1962-65	Front Wheel Opening Molding, RH
M1659B	1962-65	Front Wheel Opening Molding, LH
M1659C	1962-65	Rear Wheel Opening Molding, RH
M1659D	1962-65	Rear Wheel Opening Molding, LH
MSRP \$55.00 ea		

M1660	1966-67	Front Wheel Opening Molding, RH
M1661	1966-67	Front Wheel Opening Molding, LH
M1662	1966-67	Rear Wheel Opening Molding, RH
M1663	1966-67	Rear Wheel Opening Molding, LH
MSRP \$55.00 ea		

M1664	1968-72	Front Wheel Opening Molding, RH
M1665	1968-72	Front Wheel Opening Molding, LH
M1666	1968-72	Rear Wheel Opening Molding, RH
M1667	1968-72	Rear Wheel Opening Molding, LH
MSRP \$55.00 ea		

Qtr. Window Moldings

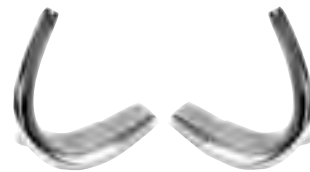

M1685	New	1966-67	Quarter Window Moldings
MSRP \$47.00 pr			

Wholesale Only. MSRP not including Taxes, Shipping and Handling. MSRP are subject to change without notice

Wholesale Only. MSRP not including Taxes, Shipping and Handling. MSRP are subject to change without notice.

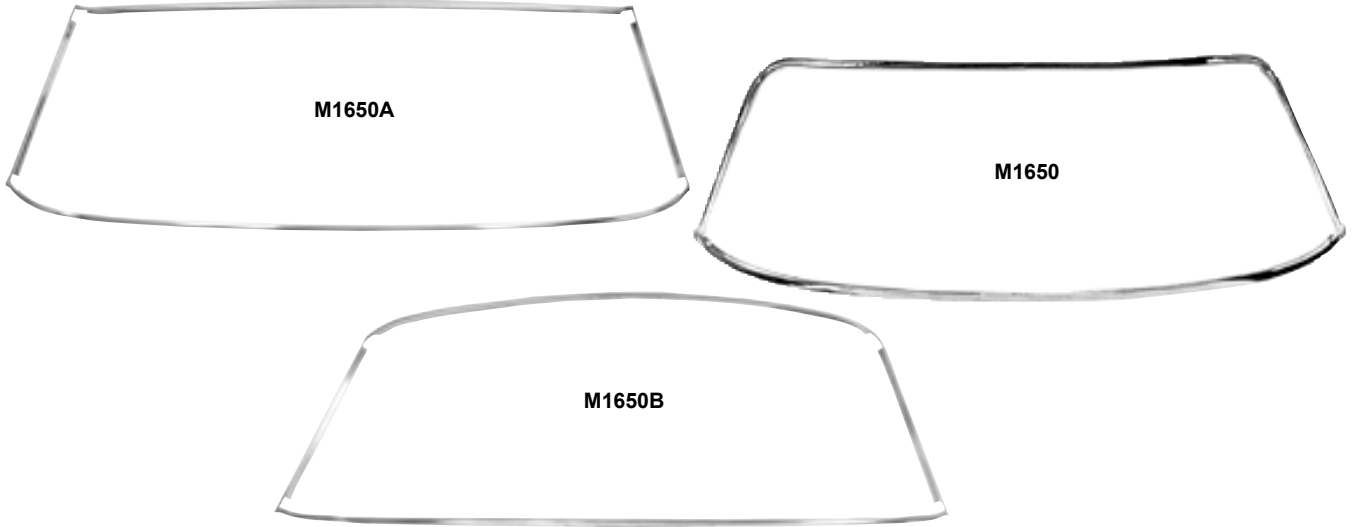

Windshield Moldings

M1650A	1962-67	Windshield Moldings, Hard Top 4 pcs.	MSRP \$170.00 set
M1650B	1962-67	Windshield Moldings, Sedan 4 pcs.	MSRP \$170.00 set
M1650	1968-72	Windshield Moldings 4 pcs.	MSRP \$152.00 set

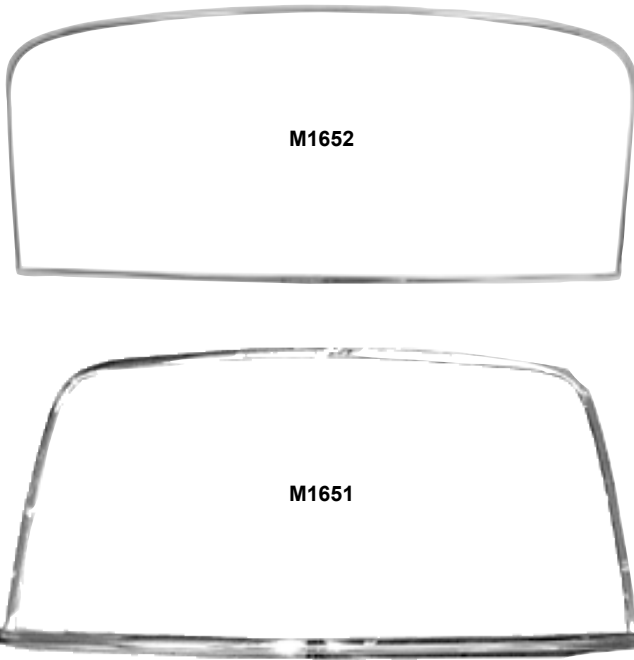

Rear Window Moldings

M1650C	1962-65	Rear Window Mldg. Set /Hard Top 8 pcs.	MSRP \$209.00 set
M1652	1966-67	Rear Window Molding Set, 5 pcs.	MSRP \$209.00 set
M1651	1968-72	Rear Window Molding Set, 5 pcs.	MSRP \$164.00 set

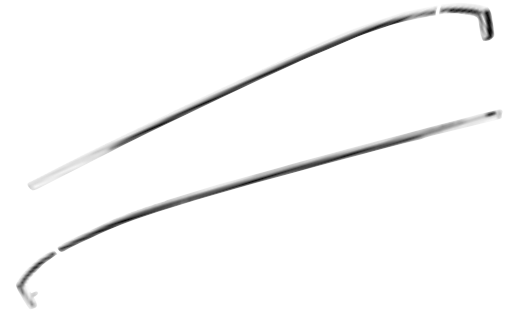

Vinyl Top Mldgs.

M1680	1968-72	Vinyl Top Molding Set 4 pcs.	MSRP \$170.00 set
-------	---------	------------------------------	--------------------------

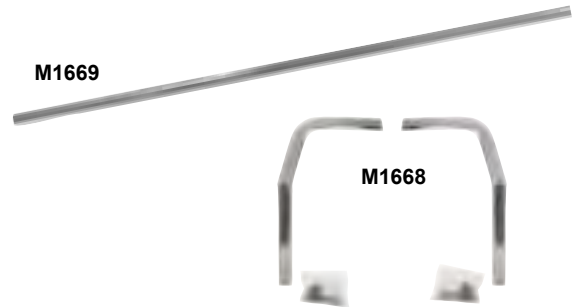

Trunk Molding

M1668	1962-65	Quarter Cove Moldings	MSRP \$84.00 pr
M1669	1962-65	Trunk Molding	MSRP \$64.00 ea

Exterior Mirrors

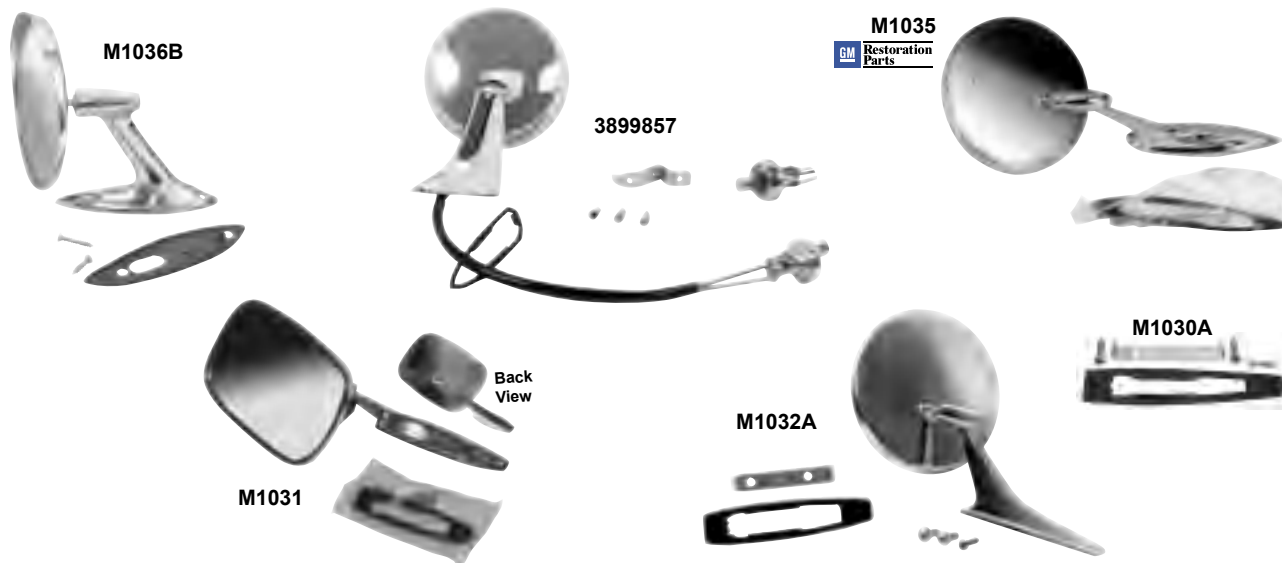

M1036B	1962	Exterior Mirror	MSRP \$54.00 ea
M1035	1963-65	Exterior Mirror, Round with "Bowtie"	MSRP \$30.00 ea
3899857	1964-66	Exterior Remote Mirror	MSRP \$150.00 ea
M1032	1966-68	Exterior Mirror, Round with "Bowtie"	MSRP \$30.00 ea
M1032A	1966-68	Exterior Mirror, Round without "bowtie"	MSRP \$30.00 ea
3921816	1968	Exterior Remote Mirror, LH	MSRP \$150.00 ea
M1030A	1967-69	Exterior Mirror Mounting Kit	MSRP \$5.00 ea
M1030	1969-72	Exterior Mirror, RH Rectangular	MSRP \$30.00 ea
M1031	1969-72	Exterior Mirror, LH Rectangular	MSRP \$30.00 ea

Drip Rail Moldings

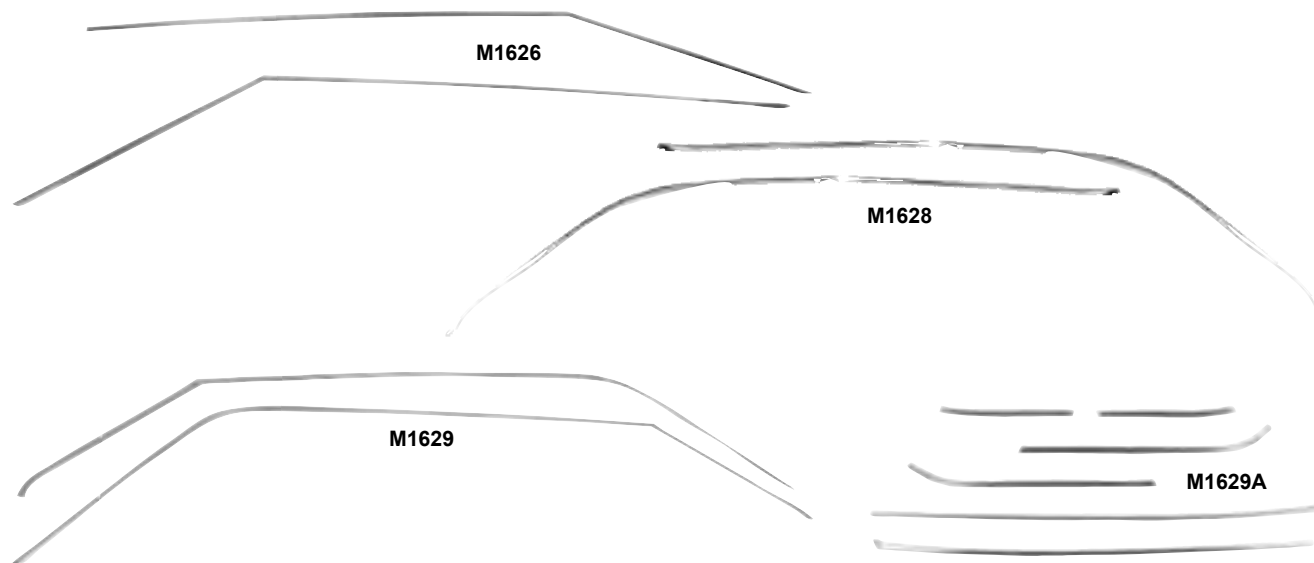

M1626	1962-65	Drip Rail Moldings 4 pcs.	MSRP \$105.00 set
M1628	1966-67	Drip Rail Moldings 2 pcs.	MSRP \$104.00 set
M1629	1968-72	Drip Rail Moldings 6 pcs.	MSRP \$202.00 set
M1629A	1973-74	Drip Rail Moldings 6 pcs.	MSRP \$170.00 set

Wholesale Only. MSRP not including Taxes, Shipping and Handling. MSRP are subject to change without notice

Wholesale Only. MSRP not including Taxes, Shipping and Handling. MSRP are subject to change without notice

M1606 1968-72 Door Frame Moldings, 8 pcs.
MSRP \$324.00 set

Door Frame Mldgs.

M1625 8 pcs (4 per side)
M1637

M1637 1962-64 Parking Lamp Extension Moldings
MSRP \$75.00 pr

M1625 1968-72 Body Side Moldings for "SS"
MSRP \$215.00 set

Body / Extension Moldings

Camera-Shy Part
dif

M1607B **New** 1962-65 Door Inner Molding, RH
M1607C **New** 1962-65 Door Inner Molding, LH
Coming Soon !

M1607 **New** 1966-67 Door Inner Molding, RH
M1607A **New** 1966-67 Door Inner Molding, LH
Coming Soon !

Door Inner Moldings

Camera-Shy Part
dif

1621XC **New** 1962-65 Quarter Inner Trim, RH
1621XD **New** 1962-65 Quarter Inner Trim, LH
Coming Soon !

1621XA **New** 1966-67 Quarter Inner Trim, RH
1621XB **New** 1966-67 Quarter Inner Trim, LH
Coming Soon !

Quarter Inner Trim

M1672
M1673
M1674

M1672 1966-67 Rocker Panel Moldings
M1673 1968-74 Rocker Panel Moldings
MSRP \$162.00 pr

M1674 1968-74 Rocker Panel Extension Moldings
MSRP \$79.00 pr

Rocker Panel Moldings

M1620
M1621
M1622
M1623

GM Restoration Parts

M1620 1962-67 Scuff Plate, RH
M1621 1962-67 Scuff Plate, LH
MSRP \$42.00 ea

M1622 1968-79 Scuff Plate, RH
M1623 1968-79 Scuff Plate, LH
MSRP \$45.00 ea

Scuff Plates

Stabilizer Rod



dii Exclusive

1621T 1968-72 Stabilizer Rod & Bushing

MSRP \$54.00 ea

Shifter Assembly



1650 1968-72 Shifter Assembly (4 spd. w/o console bench seat)

MSRP \$219.00 ea

Brake Release Handles



M1619



3893179

M1619 1962-67 Parking Brake Release Handle

MSRP \$25.00 ea

3893179 1968-79 Parking Brake Release Handle

MSRP \$14.00 ea

Parking Brake Assembly



1648 New 1966 Parking Brake Assembly

MSRP \$125.00 ea

Brake Pads/Trim

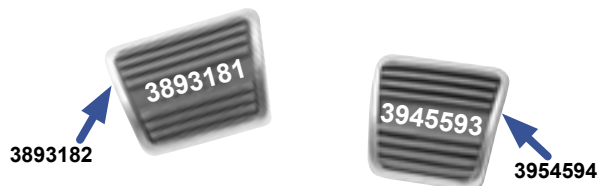

3893181	1968	Parking Brake Pad	MSRP \$5.00 ea
3893182	1968	Parking Brake Pad Trim	MSRP \$5.00 ea
3945593	1969-74	Parking Brake Pad	MSRP \$5.00 ea
3954594	1969-74	Parking Brake Pad Trim	MSRP \$5.00 ea

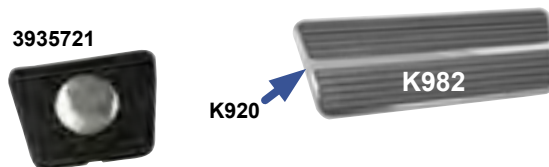

3935721	1966	Disc Brake Pedal Pad, 4 spd. Transmission	MSRP \$10.00 ea
K982	1968-77	Drum Brake Pedal Pad, Auto. Transmission	MSRP \$7.00 ea
K920	1968-77	Brake Pedal Pad Trim, Auto. Transmission	MSRP \$7.00 ea

Wholesale Only. MSRP not including Taxes, Shipping and Handling. MSRP are subject to change without notice

Wholesale Only. MSRP not including Taxes, Shipping and Handling. MSRP are subject to change without notice

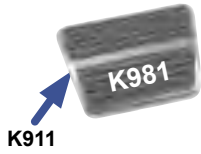

K981	1968-77	Clutch Pedal Pad	MSRP \$7.00 ea
K911	1968-77	Clutch Pedal Pad Trim	MSRP \$7.00 ea

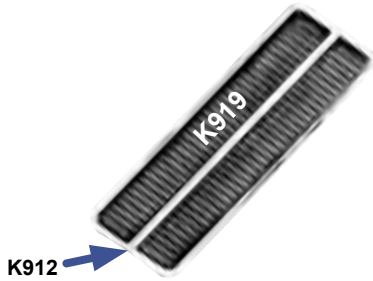

K919	1968-79	Accelerator Pedal Pad	MSRP \$7.00 ea
K912	1968-79	Accelerator Pedal Pad Trim	MSRP \$7.00 ea

Clutch / Accelerator Pads & Trim

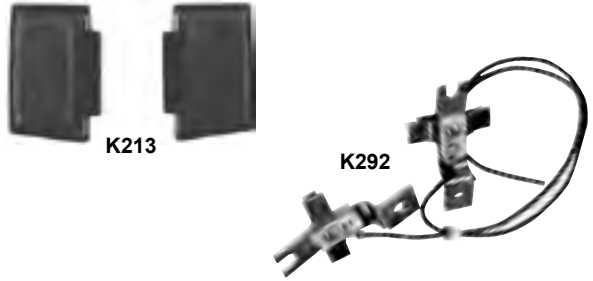

K213	1969-70	Horn Buttons	MSRP \$17.00 pr
K292	1969-70	Horn Contacts	MSRP \$29.00 pr



M1336	1968	Steering Wheel Hub, Standard	MSRP \$55.00 ea
M1337	1969-70	Steering Wheel Hub, Sport	

Horn Buttons & Contacts Steering Wheel Hubs Steering Wheels



9745764	1967	Steering Wheel for "SS", Deluxe	MSRP \$382.00 ea
9747536	1968	Steering Wheel, Deluxe	MSRP \$280.00 ea

More Steering Wheels on page 36...

Steering Wheels



3939731	1969-70	Steering Wheel, Black	MSRP \$264.00 ea
9746195	1969-70	Steering Wheel, Walnut	MSRP \$359.00 ea
3960722	1969-70	Steering Wheel, Rosewood	MSRP \$359.00 ea

Interior Mirrors



M1035C	1962-67	Rear View Mirror, Standard	MSRP \$27.00 ea
916177	1962-68	Rear View Mirror, 8 inch	MSRP \$49.00 ea
911366	1968-72	Rear View Mirror, 10 inch	MSRP \$49.00 ea
1154F	1973-81	Rear View Mirror, Day/Night, 10 inch	MSRP \$59.00 ea
8752692	1968-72	Rear View Mirror Bracket	MSRP \$40.00 ea

Wholesale Only. MSRP not including Taxes, Shipping and Handling. MSRP are subject to change without notice

Wholesale Only. MSRP not including Taxes, Shipping and Handling. MSRP are subject to change without notice



M1338 1965-73 Sun Visor Support
MSRP \$20.00 ea

Visor Support



K883G 1968-72 Seat Belt Buckle Cover, With "GM" insert
MSRP \$30.00 ea

Belt Buckle Cover



FL01 1962-74 "Body by Fisher" decal **MSRP \$2.00 ea**

Sill Decal

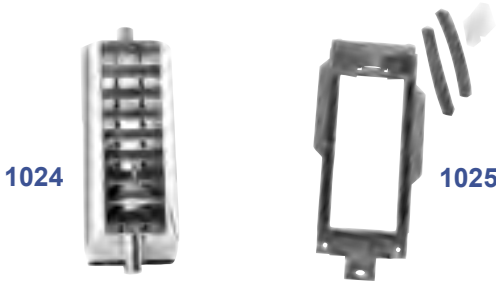

1024 New 1969-72 Dash A/C Vent
MSRP \$27.00 ea

1025 New 1969-72 Dash A/C Vent Bezel
MSRP \$27.00 ea

A/C Vent / Bezel



K15 1967-72 Seat Track Adjusting Knob, Chrome
MSRP \$9.00 ea
 K75 1968-72 Seat Back Locking Knob, Chrome
MSRP \$10.00 ea

Seat Knobs

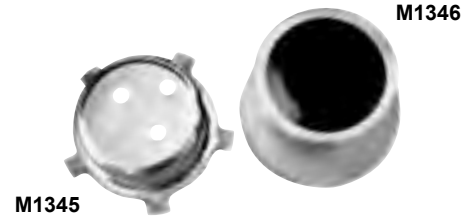

M1345 1969-70 Wheel Cap Retainer
MSRP \$7.00 ea
 M1346 1969-70 Wheel Center
MSRP \$19.00 ea

Wheel Centers



M1617 1966-67 Radio Bezel
MSRP \$34.00 ea

Radio Bezel

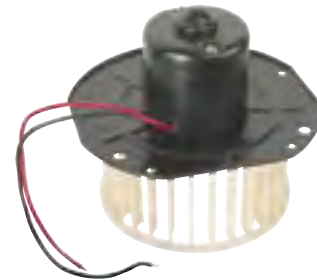

1041W New 1968-74 Heater Blower Motor w/o A/C
MSRP \$80.00 ea

Heater Blower Motor

Heater Boxes & Case



1041K



1041L

1041K 1967-75 Heater Box w/o A/C, Sm. Block **MSRP \$39.00 ea**

1041L 1968-70 Heater Box, Big Block **MSRP \$62.00 ea**



1041R 1969-72 Heater Case (Core Section) w/o A/C **MSRP \$334.00 ea**

Side Markers



K70	1968	Front Side Marker, Clear	MSRP \$14.00 ea
K71	1968-69	Rear Side Marker, Red	MSRP \$14.00 ea
K72	1968-69	Side Marker Bezel	MSRP \$10.00 ea
M1649C	1970-74	Front Side Marker Lens Assy.	MSRP \$50.00 ea
M1649D	1970-74	Rear Side Marker Lens Assy.	MSRP \$50.00 ea
M1649A	1970-74	Front Side Marker Lamp Bezel	MSRP \$22.00 ea
M1649B	1970-74	Rear Side Marker Lamp Bezel	MSRP \$22.00 ea

Parking Lamp Lenses

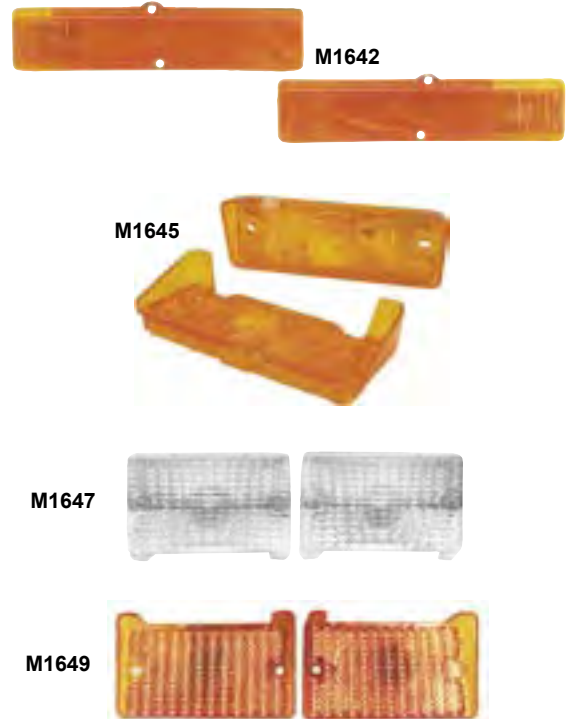

M1642	1963-64	Parking Lamp Lenses, Amber
M1645	1968-69	Parking Lamp Lenses, Amber
M1647	1970	Parking Lamp Lenses, Clear
M1649	1971-72	Parking Lamp Lenses, Amber

MSRP \$27.00 pr

Wholesale Only. MSRP not including Taxes, Shipping and Handling. MSRP are subject to change without notice

Wholesale Only. MSRP not including Taxes, Shipping and Handling. MSRP are subject to change without notice



M1643 1962-64 Parking Lamp Lens Bezels
MSRP \$67.00 pr



M1640 1962-64 Parking Lamp Assembly, RH
M1641 1962-64 Parking Lamp Assembly, LH
MSRP \$50.00 ea

M1643A 1966-67 Parking Lamp Assembly, Fits RH or LH, Amber
Call for Price

M1644 1968-69 Parking Lamp Assembly, Fits RH or LH, Amber
MSRP \$65.00 ea

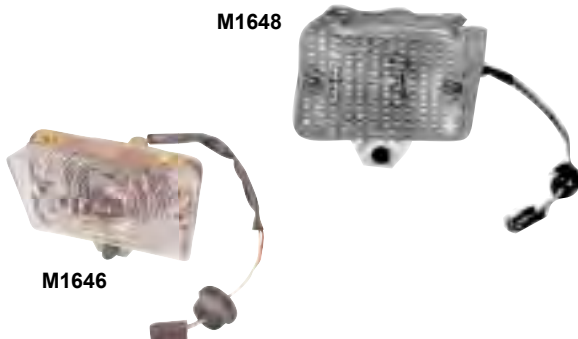

M1646 1970 Parking Lamp Assembly, Fits RH or LH, Clear
MSRP \$67.00 ea

M1648 1971-72 Parking Lamp Assembly, Fits RH or LH, Amber
MSRP \$67.00 ea

Parking Lamp Bezels

Parking Lamp Assys.



899439 1962-64 Tail Lamp Assembly
MSRP \$100.00 ea



M1618 1966-72 License Plate Lamp
MSRP \$27.00 ea

Tail Lamp Assy.

Lic. Plate Lamp



M1013 1964-73 Headlamp Switch
MSRP \$14.00 ea

LH01 1964-72 Headlamp Dimmer Switch
MSRP \$7.00 ea

M1013B 1974-84 Headlamp Switch
MSRP \$19.00 ea

Headlamp Switches

Cig. Lighter



7031884 1967-68 Cigarette Lighter **MSRP \$27.00 ea**

Dome Lamp / Lens



4866918 1962-69 Dome Light Base, Nova/Chevy II

MSRP \$9.00 ea

K35 1962-69 Dome Light Lens

MSRP \$5.00 ea



8732777 1971-79 Dome Light Lens

MSRP \$7.00 ea

20030351 1971-79 Dome Light Base

MSRP \$20.00 ea

Miscellaneous

GM01



GM01 1968-72 Clothes Hanger Hooks

MSRP \$15.00 pr

GM02

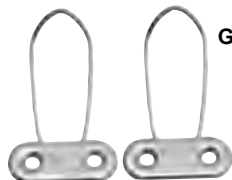

GM02 1968-72 Shoulder Harness Hooks

MSRP \$10.00 pr

Horns



1010H



1010L

1010H 1964-72 Horn, High

1010L 1964-72 Horn, Low

MSRP \$75.00 ea

Pitman Arm



1638 **New** 1962-67 Pitman Arm, Manual Steering

MSRP \$114.00 ea

Ctrl. Arm Bumper

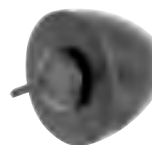

1007 1968-74 Control Arm Bumper

MSRP \$5.00 ea

Body Bushing Kit



M1609 1968-74 Body Bushing Kit

MSRP \$47.00 kit

Wholesale Only. MSRP not including Taxes, Shipping and Handling. MSRP are subject to change without notice

Wholesale Only. MSRP not including Taxes, Shipping and Handling. MSRP are subject to change without notice



266	1962-64	Original	MSRP \$55.00 kit
267	1965	Original	MSRP \$55.00 kit
268	1966-67	Original	MSRP \$55.00 kit

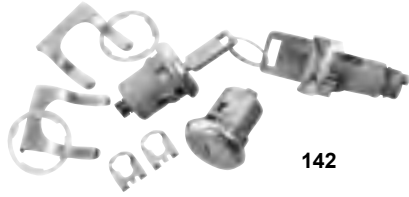

142	1962-64	Rectangular	MSRP \$49.00 kit
142A	1962-64	Octagonal	MSRP \$54.00 kit
143A	1965	Original	MSRP \$54.00 kit
104	1966-67	Later	MSRP \$30.00 kit
104A	1966-67	Original	MSRP \$37.00 kit
105	1968	Later	MSRP \$37.00 kit
105A	1968	Original	MSRP \$44.00 kit
106	1969-78	Later	MSRP \$37.00 kit

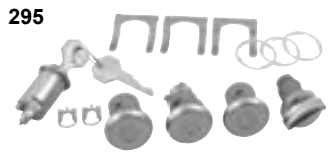

* Cylinder & Keys ONLY. Case not included.

295	1962-64	Original	MSRP \$77.00 kit
296	1965	Original	MSRP \$77.00 kit
288	1966-67	Original	MSRP \$75.00 kit
336	1968	Original	MSRP \$77.00 kit
337	1969-78	Original	MSRP \$77.00 kit

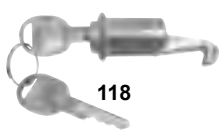

* Cylinder & Keys ONLY. Case not included.

163	1962-65	Later	MSRP \$24.00 kit
163A	1962-65	Original	MSRP \$27.00 kit
118	1966-67	Later	MSRP \$24.00 kit
118A	1966-67	Original	MSRP \$27.00 kit
119	1968-79	Later	MSRP \$42.00 kit
119A	1968	Original	MSRP \$49.00 kit

Ign., Door & Trunk

Ignition & Door Lock Kits

Ign., Door, Glove, Trunk

Glovebox Locks

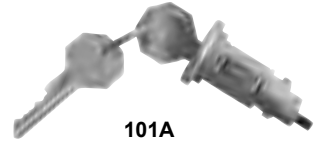

157	1962-64	Octagonal	MSRP \$14.00 kit
161	1962-64	Original	MSRP \$17.00 kit
158	1965	Octagonal	MSRP \$12.00 kit
158A	1965	Original	MSRP \$15.00 kit
100	1966-67	Later	MSRP \$14.00 kit
100A	1966-67	Original	MSRP \$17.00 kit
101	1968	Later	MSRP \$17.00 kit
101A	1968	Original	MSRP \$20.00 kit
102	1969-78	Later	MSRP \$17.00 kit

See also our Lock Section for more details...

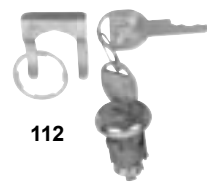

112	1962-79	Later	MSRP \$17.00 kit
112A	1962-67, 69-79	Original	MSRP \$22.00 kit
112B	1968	Original	MSRP \$22.00 kit

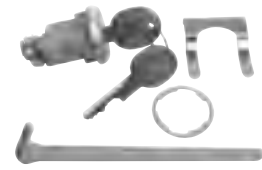

1575	1962-79	Later	MSRP \$14.00 kit
------	---------	-------	-------------------------

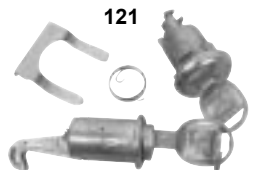

* Cylinder & Keys ONLY. Case not included.

164	1962-65	Later	MSRP \$39.00 kit
164A	1962-65	Original	MSRP \$44.00 kit
121	1966-67	Later	MSRP \$37.00 kit
121A	1966-67	Original	MSRP \$42.00 kit
150A	1968	Original	MSRP \$47.00 kit
150	1968-79	Later	MSRP \$40.00 kit

Ignition Locks

Trunk Locks & Kit

Glovebox & Trunk Kits



RetroSound

Modern Sound for Your Classic

CLASSIC CAR RADIO & ACCESSORIES

NOVA



2010 RetroSound Catalog Version 1

ORDER LINE 1-866-640-1324

2010

FAX LINE 1-905-850-1722



RetroSound[®]
Modern Sound for your Classic

<http://www.retrosoundcanada.com>

INDEX

Index

RADIO SYSTEM

CLASSIC SOUND:.....	RSC-1
MODEL ONE:.....	RSC-2
RADIO SPECIFICATION:.....	RSC-3
FACEPLATE:.....	RSC-4
ACCESSORIES:	
KNOBS:.....	RSC-5
DASH HOLE CUPS:.....	RSC-5
REMOTE:.....	RSC-5
IR CABLE:.....	RSC-5

LOUDSPEAKERS

DESCRIPTION:.....	RSC-6
DVC SPEAKER:.....	RSC-7
SVC SPEAKER:.....	RSC-8



RetroSound[®]
Modern Sound for your Classic

<http://www.retrosoundcanada.com>

RADIO SYSTEM



Revolutionary patent - pending
INFINIMOUNT system allows for
infinite movement of bracket & shaft
knobs to meet virtually any install need!

Front and Rear Aux-in analog inputs
allow you to plug in any portable device
(Mp3 player, satellite unit, Portable CD)
The possibilities are endless!

CS-900

FEATURES:

- FRONT AUX INPUT, PLUG IN ANY MP3 PLAYER OR OTHER PORTABLE DEVICE, (CELL PHONE, ETC.)
- LCD DISPLAY W/ ENHANCED VIEWING ANGLE & DAYLIGHT COMPATIBLE W/ CLOCK FUNCTION
- AM/FM PLL TUNER WITH 30 PRESETS
- 2 PAIR RCA PRE AMP OUTPUTS TO ADD AN EXTERNAL AMPLIFIER
- PATENT PENDING INFINIMOUNT ADJUSTABLE SHAFT SYSTEM W/ REMOVABLE UNIVERSA BRACKET (INCLUDED)
- INSULATED BRACKET SYSTEM AND EXTERNAL SHAFT SYSTEM REDUCE ELECTRICAL NOISE INHERENT IN OLDER VEHICLES
- ADJUSTABLE FACEPLATE ANGLE, ALLOWS MOUNTING OF FACEPLATE DISPLAY TO VIRTUALLY ANY DASH
- SMALL 3.55"W x 6.57"D x 1.55"H INSTALLATION SIZE
- IR RECEIVER ON FACEPLATE (REMOTE OPTIONAL)

ORDER LINE 1-866-640-1324

2010

FAX LINE 1-905-850-1722

RSC - 1



RetroSound[®]
Modern Sound for your Classic

<http://www.retrosoundcanada.com>

RADIO SYSTEM

Rear - mounted USB input allows you to directly play Mp3 or WMA digital files off of any commonly available and inexpensive flash/thumb drive No Ipod Needed!

USB **mp3**



MODEL ONE CHROME



Front and Rear Aux-in analog inputs allow you to plug in any portable device (Mp3 player, satellite unit, Portable CD) The possibilities are endless!



MODEL ONE BLACK

FEATURES:

- FRONT AUX INPUT, PLUG IN ANY MP3 PLAYER OR OTHER ORTABLE DEVICE, (CELL PHONE, ETC.)
- LCD DISPLAY W/ ENHANCED VIEWING ANGLE & DAYLIGHT COMPATIBLE W/ CLOCK FUNCTION
- AM/FM PLL TUNER WITH 30 PRESETS
- 2 PAIR RCA PRE AMP OUTPUTS TO ADD AN EXTERNAL AMPLIFIER
- PATENT PENDING INFINIMOUNT ADJUSTABLE SHAFT SYSTEM W/ REMOVABLE UNIVERSAL BRACKET (INCLUDED)
- INSULATED BRACKET SYSTEM AND EXTERNAL SHAFT SYSTEM REDUCE ELECTRICAL NOISE INHERENT IN OLDER VEHICLES
- ADJUSTABLE FACEPLATE ANGLE, ALLOWS MOUNTING OF FACEPLATE DISPLAY TO VIRTUALLY ANY DASH
- SMALL 3.55"W x 6.57"D x 1.55"H INSTALLATION SIZE
- IR RECEIVER ON FACEPLATE (REMOTE INCLUDED)
- LCD DISPLAY SHOWS MP3/WMA TRACK NAME
- REAR MOUNTED USB PORT, PLUG IN ANY USB FLASH DRIVE AND PLAY MP3/WMA FILES
- FULL FUNCTION 18 KEY IR REMOTE CONTROL

ORDER LINE 1-866-640-1324

2010

FAX LINE 1-905-850-1722

RSC - 2



RetroSound[®]
Modern Sound for your Classic

<http://www.retrosoundcanada.com>

RADIO SYSTEM



CLASSIC SOUND RADIO SYSTEM SPECIFICATIONS:

Tuner Section

FM

Tuning Range (Eu & US Tuning Capable)	87.5 - 107.9MHz
Antenna Terminal	External Antenna Connector
Usable Sensitivity	12.5 dBf
Selectivity	75dB @ 400kHz
Signal to Noise Ratio	62 dB (Stereo), 67 dB (Mono)
Harmonic Distortion @ 1 kHz	0.8% (Stereo), 0.5% (Monaural)
Separation	32 dB @ 1kHz
Frequency Response	30 - 16,000 Hz

AM (Eu & US Tuning Capable)

Tuning Range	530 - 1710 kHz
Antenna Terminal	External Antenna Connector

General

Dimensions (Main Body Only)	3.5"W x 6.7"D x 1.5"H
Power Requirements	10.5 - 14.4V
Current Consumption	Max. 10A
Current Consumption	< 3.5 mA
Output Power	22 x 4w RMS 60x4 Max Power
(@ 14.4V @ 4 ohm @ 1% THD)	
Output Impedance	4 - 8 ohm
Low Level Output (4 Channels)	2.5V
AUX Input (Rear)	2V / 6 kΩ
AUX Input (Front)	500 mV / 6 kΩ

ORDER LINE 1-866-640-1324

2010

FAX LINE 1-905-850-1722

RSC - 3



RetroSound[®]
Modern Sound for your Classic

<http://www.retrosoundcanada.com>

RADIO FACEPLATE

CHEVY NOVA



RS-6265NOVAKT



RS-6667NOVAKT



RS-6879NOVAKT



RS-UNIVFP

SKU#	YEAR	VEHICLE
RS-6265NOVAKT	1962-65	NOVA
RS-6667NOVAKT	1966-67	NOVA
RS-6879NOVAKT	1968-79	NOVA
RS-UNIVFP	(UNIVERSAL)	NOVA

ORDER LINE 1-866-640-1324

2010

FAX LINE 1-905-850-1722



ACCESSORIES

KNOBS



6885ACR



6885ABK



6885FBCRB



6885FBCRB2



6885FCRBKR



EUROKNBACR



EUROKNBABK



EUROKNBFCRBKR



EUROKNBFBKCR



DOKNOBKIT



556KNOBKIT



57KNOBKIT

94" REMOTE IR CABLE



DASH HOLE CUPS



57 CHVY CUPS



68 - 67 NOVA CUPS

REMOTE CONTROL





RetroSound[®]
Modern Sound for your Classic

<http://www.retrosoundcanada.com>

LOUDSPEAKERS

RetroSound Loudspeakers

Why purchase RetroSound™ speakers over your original or "other" commercially available speakers for your classic car? Check out the exploded view below to learn more about the detail and quality that goes into each speaker we make!



RetroSound replacement speakers have set the industry standard in OEM for your classic vehicle!

Designed and tooled from the ground up, the speakers meet the demand of today's high performance amplifiers while maintaining factory dimensions for original location mounting and are compatible with all digital music sources. The "N" Series features 4 models that feature ultra thin 1.77" mounting profiles for fit in virtually any installation application. These 4 models with neodymium magnet structures which are 5 times more powerful than standard speaker magnets, allowing for a substantial reduction in mounting depth and feature enhanced power handling and heat dissipation characteristics. Their Dual Voice Coil design (on 3 models) allows you to connect 2 stereo channels from your radio to one speaker, providing you with maximum sound for a single speaker application!

ORDER LINE 1-866-640-1324

2010

FAX LINE 1-905-850-1722

RSC - 6



RetroSound[®]
Modern Sound for your Classic

<http://www.retrosoundcanada.com>

LOUDSPEAKERS

RetroSound DVC Speaker Technical Specification



ORDER LINE 1-866-640-1324

2010

FAX LINE 1-905-850-1722

RSC - 7



RetroSound[®]
Modern Sound for your Classic

<http://www.retrosoundcanada.com>

LOUDSPEAKERS

RetroSound SVC Speaker Technical Specification



ORDER LINE 1-866-640-1324

2010

FAX LINE 1-905-850-1722

RSC - 8