

# IMPALA™ & FULL SIZE



# 2010

Golden Leaf Automotive

# Full Size Chevy® Index

Air Vent Assemblies: FS2  
Battery Trays, Clamps, Bolts: FS1  
Door Latches: FS2

Front Valances: FS1  
Fuel Senders: FS1  
Headlamp Bezels: FS2

Hood Hinges & Latches: FS2  
Parking Brake Assemblies: FS2  
Scuff Plates: FS2



General Motors Trademarks  
are used under License to  
Dynacorn International Inc.

## Impala™ Index

### A

A/C Vent Ball: 38  
Arm Rest Bases: 24

### B

“Body By Fisher” Decal: 36  
Back Up Lenses & Trim: 38  
Battery Trays, Clamps & Bolts: 6  
Body Shims: 4  
Bumpers: 1  
    Brackets: 2  
    Guards: 2  
    Reinforcement: 2  
Bushings, Body & Trailing Arm: 40

### C

Cigarette Lighter: 39  
Clutch Countershaft (Z-Bar): 35  
Control Arm Bumper: 40  
Cowl Panels, Outer: 6  
Cross Rail Panel: 16

### D

Dash Panel, Steel: 9  
Deck Lid Filler Panel: 14  
Door Glass Assemblies: 20  
    Handles  
        Exterior: 21, 22  
        Interior: 22  
    Hinges: 20  
    Latches & Striker: 21  
    Lock Knobs & Molding: 23  
    Lower Window Frames: 20  
    Shells: 20  
Drip Rail Molding: 33

### E

Emblems: 24  
Eyebrow Moldings: 26

### F

Fender  
    Brace Skirts: 4  
    Front: 3  
    Inner: 4  
    Moldings: 30  
    To Valance Bracket: 4  
Floor Pans: 9, 10  
Plug: 9

Floor Pan Under Supports: 10  
Fresh Air Vent Assemblies: 38  
Fuel Sending Units: 15  
    Gasket & Locking Ring: 15

### G

Gas Filler Door: 14  
Gas Tanks, Straps & Braces: 14  
Glovebox Door & Hinge: 35  
Grilles & Components: 25-28  
Grille Molding: 25

### H

Header Panel: 3  
Headlamp Bezels: 25-28  
Headlamp Mounting Buckets: 25-28  
Headlamp Switches: 39  
Heater Box Assemblies & Cores: 37  
Heater Core Case Vent: 37  
Hoods: 7  
    Hinges, Latches, Supports: 8  
    Moldings & Spears: 29  
Horns: 40  
Horn Caps: 36

### L

License Panels: 34  
License Plate Bracket: 14  
Locks: 40

### M

Mirrors  
    Exterior: 31  
    Interior: 37

### P

Parking Brake  
    Assemblies & Cable Guide Pulley: 34  
    Release Handle: 35  
Parking Lamp Components: 38  
Pedal Pads & Trim: 35

### Q

Quarter “B” Pillar Panels: 11  
Quarter Extension Molding: 33  
Quarter Panels: 12  
Quarter Panel Molding: 32

### R

Radiator Supports: 5  
Rear Body Panels: 15  
Rear Seat Floor Pan: 10  
Rocker Panels: 11  
Rocker Panel Molding & Clips: 31  
Roof Drip Rails: 9

### S

Scuff Plates: 31  
Seat Belts: 42  
Seat Frame Assemblies: 12  
Seat Platform Braces: 11  
Steering Wheels: 36  
Sun Visor Brackets: 37

### T

Tail Lamp Components: 39  
Tail Light Mounting Panels: 13  
Tail Panel Brace: 15  
Transmission Support, Crossmember: 10  
Trunk Divider Panel: 16  
Trunk  
    Floor Pans: 17-19  
    Floor Drop Offs: 19  
Trunk  
    Lids & Latch: 16  
    Molding: 33  
    Shelf Panel: 17  
    Spear: 32  
    Under Braces: 19  
    Weatherstrip Channel: 19

### V

Vent Window Actuator: 21  
Vent Window Cranks: 22

### W

Wheel Houses & Braces: 13  
Wheel Opening Moldings: 29, 30  
Window Cranks: 23  
Window Moldings  
    Front: 30  
    Rear: 32  
Window Regulators: 21  
Window Seals, Rubber: 24  
Windshield Washer Bottle Bracket: 6  
Windshield Wiper Switches: 39  
Wiper Arms: 29

Wholesale Only. MSRP not including Taxes, Shipping and Handling. MSRP are subject to change without notice

## Front Valances



|      |      |                                  |                  |
|------|------|----------------------------------|------------------|
| 4002 | 1955 | Front Valance Assembly, 3 pieces | MSRP \$182.00 ea |
| 4000 | 1956 | Front Valance Assembly           | MSRP \$182.00 ea |
| 4001 | 1957 | Front Valance Assembly           | MSRP \$190.00 ea |

## Battery Trays & Clamps

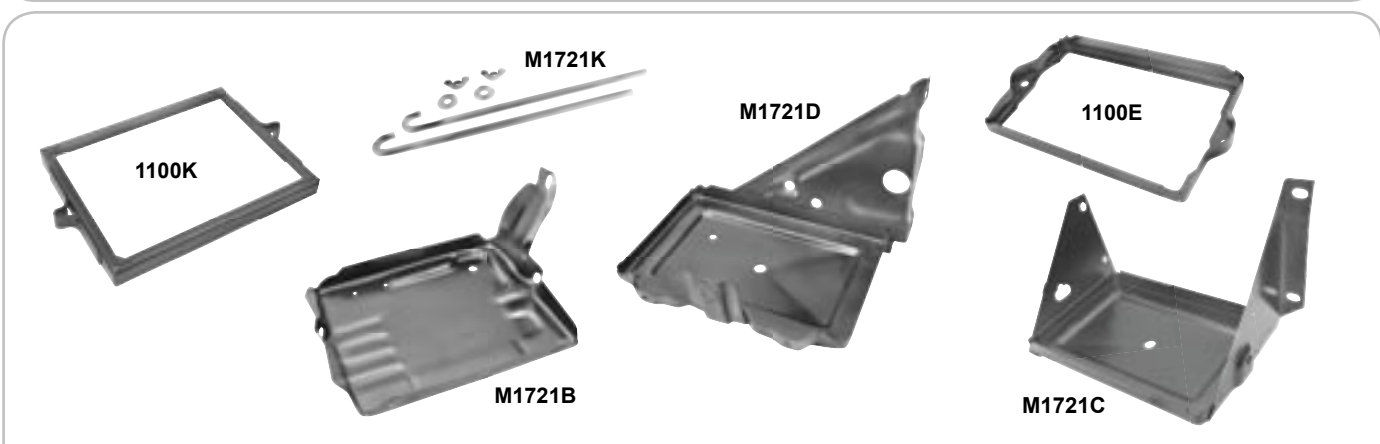

|        |         |                     |                 |
|--------|---------|---------------------|-----------------|
| 1100K  | 1940-54 | Battery Clamp       | MSRP \$19.00 ea |
| M1721B | 1949-54 | Battery Tray        | MSRP \$37.00 ea |
| M1721K | 1949-58 | Battery Clamp Bolts | MSRP \$7.00 pr  |
| M1721C | 1955-56 | Battery Tray        | MSRP \$29.00 ea |
| 1100E  | 1955-57 | Battery Hold Down   | MSRP \$14.00 ea |
| M1721D | 1957    | Battery Tray        | MSRP \$29.00 ea |

## Fuel Senders

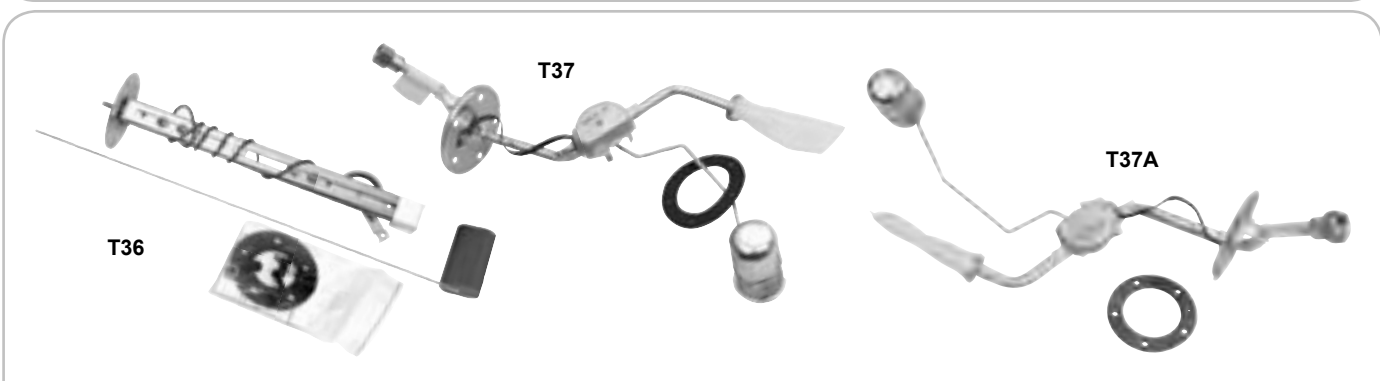

|      |         |                          |                 |
|------|---------|--------------------------|-----------------|
| T36  | 1931-54 | Fuel Sending Unit        | MSRP \$50.00 ea |
| T37  | 1955-57 | Fuel Sending Unit, 5/16" | MSRP \$67.00 ea |
| T37A | 1955-57 | Fuel Sending Unit, 3/8"  | MSRP \$49.00 ea |



## Headlamp Bezels



M1718A 1949-52 Headlamp Bezels MSRP \$35.00 pr

## Door Latches

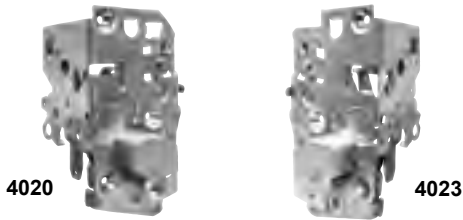

|      |         |                |
|------|---------|----------------|
| 4020 | 1955    | Door Latch, RH |
| 4021 | 1955    | Door Latch, LH |
| 4022 | 1956-57 | Door Latch, RH |
| 4023 | 1956-57 | Door Latch, LH |

**MSRP \$114.00 ea**

## Air Vent Assemblies

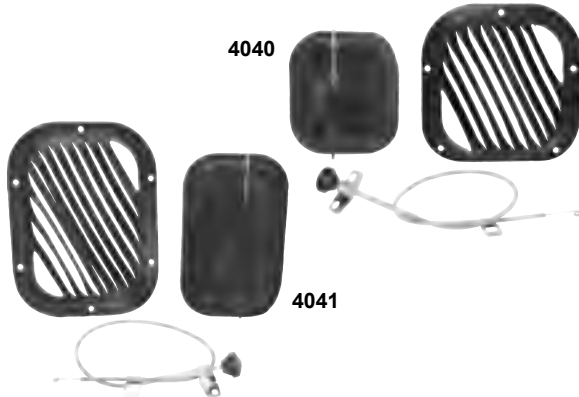

|      |         |                       |
|------|---------|-----------------------|
| 4040 | 1955-56 | Air Vent Assembly, RH |
| 4041 | 1955-56 | Air Vent Assembly, LH |

**MSRP \$109.00 ea**

## Scuff Plates



**M4000**

|       |     |         |                                 |
|-------|-----|---------|---------------------------------|
| M4000 | New | 1955-57 | Scuff Plates for 2 door, 2 pcs. |
| M4001 | New | 1955-57 | Scuff Plates for 4 door, 4 pcs. |

**MSRP \$75.00 pr**  
**MSRP \$119.00 set**

## Hood Hinges

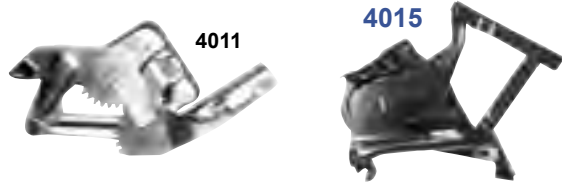

|      |         |                |
|------|---------|----------------|
| 4010 | 1955-56 | Hood Hinge, RH |
| 4011 | 1955-56 | Hood Hinge, LH |

**MSRP \$80.00 ea**

|      |     |      |                |
|------|-----|------|----------------|
| 4014 | New | 1957 | Hood Hinge, RH |
| 4015 | New | 1957 | Hood Hinge, LH |

**MSRP \$152.00 ea**

## Hood Latches

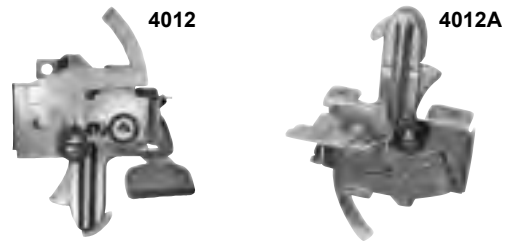

|       |      |            |
|-------|------|------------|
| 4012  | 1955 | Hood Latch |
| 4012A | 1956 | Hood Latch |
| 4013  | 1957 | Hood Latch |

**MSRP \$94.00 ea**

## Parking Brake Assys.

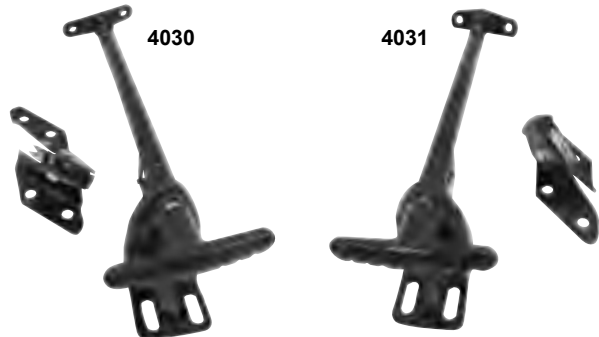

|      |         |                        |
|------|---------|------------------------|
| 4030 | 1955-56 | Parking Brake Assembly |
| 4031 | 1957    | Parking Brake Assembly |

**MSRP \$125.00 ea**

Wholesale Only. MSRP not including Taxes, Shipping and Handling. MSRP are subject to change without notice



# IMPALA™



## Bumpers

Wholesale Only. MSRP not including Taxes, Shipping and Handling. MSRP are subject to change without notice



|       |      |                        |                   |
|-------|------|------------------------|-------------------|
| 1705K | 1962 | Front Bumper           | MSRP \$497.00 set |
| 1705L | 1962 | Rear Bumper            | MSRP \$497.00 set |
| 1705B | 1963 | Front Bumper, 3 pieces | MSRP \$497.00 set |
| 1705C | 1963 | Rear Bumper, 3 pieces  | MSRP \$497.00 set |

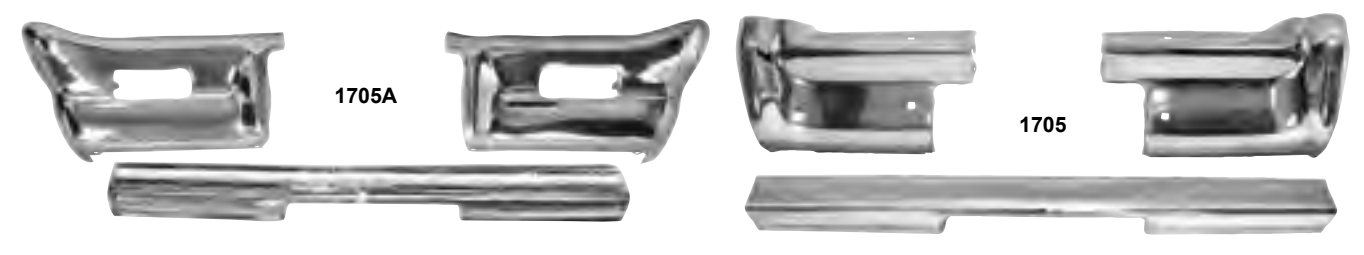

|       |      |                        |                   |
|-------|------|------------------------|-------------------|
| 1705A | 1964 | Front Bumper, 3 pieces | MSRP \$497.00 set |
| 1705  | 1964 | Rear Bumper, 3 pieces  | MSRP \$497.00 set |

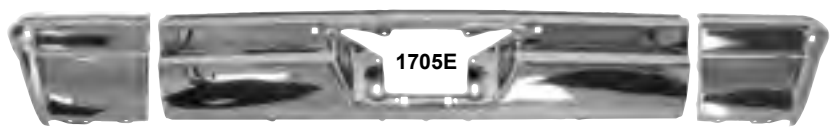

|       |     |      |                       |                   |
|-------|-----|------|-----------------------|-------------------|
| 1705M | New | 1965 | Front Bumper          | MSRP \$497.00 set |
| 1705E |     | 1965 | Rear Bumper, 3 pieces | MSRP \$497.00 set |

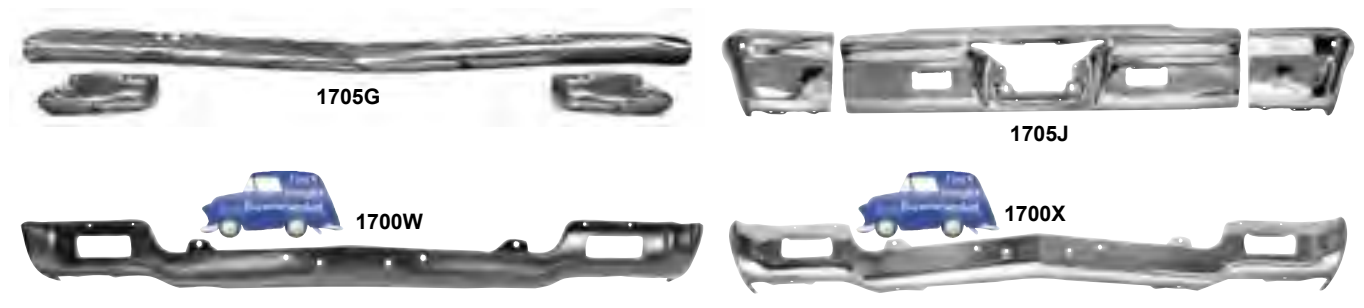

|       |      |                             |                   |
|-------|------|-----------------------------|-------------------|
| 1705G | 1966 | Front Bumper, 3 pieces      | MSRP \$497.00 set |
| 1700W | 1966 | Front Lower Bumper, Painted | MSRP \$305.00 set |
| 1700X | 1966 | Front Lower Bumper, Chrome  | MSRP \$420.00 set |
| 1705J | 1966 | Rear Bumper, 3 pieces       | MSRP \$497.00 set |

## Bumper Guards



1705GA 1966 Front Bumper Guards  
**MSRP \$87.00 pr**

## Bumper Reinforcement



|                        |     |         |                                       |
|------------------------|-----|---------|---------------------------------------|
| 1705H                  | New | 1962-63 | Front Bumper Center Reinforcement Bar |
| <b>Coming Soon!</b>    |     |         |                                       |
| 1700R                  |     | 1964    | Front Bumper Center Reinforcement Bar |
| <b>MSRP \$72.00 ea</b> |     |         |                                       |

## Bumper Brackets, Brace



|       |         |                                    |                          |
|-------|---------|------------------------------------|--------------------------|
| 1700K | 1962-64 | Front Bumper Bracket, RH           | <b>MSRP \$25.00 ea</b>   |
| 1700L | 1962-64 | Front Bumper Bracket, LH           | <b>MSRP \$25.00 ea</b>   |
| 1700S | 1964    | Front Bumper Center Brace          | <b>MSRP \$62.00 ea</b>   |
| 1700T | 1963    | Front Bumper Brackets, 5 pieces    | <b>MSRP \$184.00 set</b> |
| 1700U | 1963    | Rear Bumper Brackets, 4 pieces     | <b>MSRP \$170.00 set</b> |
| 1700M | 1964    | Front Bumper Brackets, RH 3 pieces | <b>MSRP \$67.00 set</b>  |
| 1700N | 1964    | Front Bumper Brackets, LH 3 pieces | <b>MSRP \$67.00 set</b>  |
| 1700P | 1964    | Rear Bumper Brackets, RH 2 pieces  | <b>MSRP \$67.00 set</b>  |
| 1700Q | 1964    | Rear Bumper Brackets, LH 2 pieces  | <b>MSRP \$67.00 set</b>  |
| 1707A | 1966    | Front Bumper Arms, 4 pieces        | <b>MSRP \$152.00 set</b> |

**Wholesale Only. MSRP not including Taxes, Shipping and Handling. MSRP are subject to change without notice**



# IMPALA™



Wholesale Only. MSRP not including Taxes, Shipping and Handling. MSRP are subject to change without notice



## Bumper Fillers

|        |     |      |                     |                         |
|--------|-----|------|---------------------|-------------------------|
| 1700CA | New | 1962 | Front Bumper Filler | <b>MSRP \$109.00 ea</b> |
| 1700   |     | 1963 | Front Bumper Filler | <b>MSRP \$109.00 ea</b> |
| 1700C  |     | 1964 | Front Bumper Filler | <b>MSRP \$132.00 ea</b> |



|      |      |              |                         |
|------|------|--------------|-------------------------|
| 1739 | 1966 | Header Panel | <b>MSRP \$182.00 ea</b> |
|------|------|--------------|-------------------------|

## Header Panel

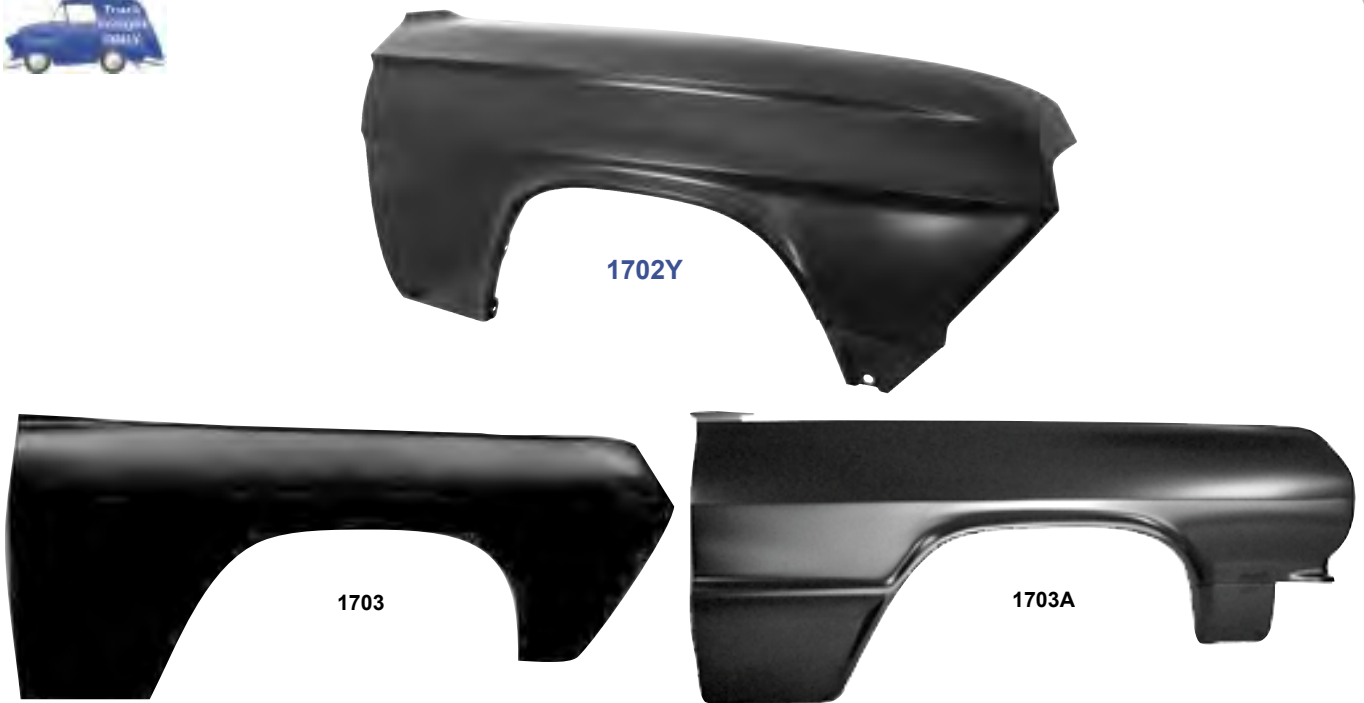

## Front Fenders

|       |     |      |                  |                         |
|-------|-----|------|------------------|-------------------------|
| 1702Y | New | 1962 | Front Fender, RH | <b>MSRP \$574.00 ea</b> |
| 1702Z | New | 1962 | Front Fender, LH | <b>MSRP \$574.00 ea</b> |
| 1703  |     | 1963 | Front Fender, RH | <b>MSRP \$477.00 ea</b> |
| 1704  |     | 1963 | Front Fender, LH | <b>MSRP \$477.00 ea</b> |
| 1703A |     | 1964 | Front Fender, RH | <b>MSRP \$497.00 ea</b> |
| 1704A |     | 1964 | Front Fender, LH | <b>MSRP \$497.00 ea</b> |
| 1704D | New | 1966 | Front Fender, RH | <b>MSRP \$574.00 ea</b> |
| 1704E | New | 1966 | Front Fender, LH | <b>MSRP \$574.00 ea</b> |



## Body Shims



1000F



1000D



1000E



GM03

|       |         |                                |                         |
|-------|---------|--------------------------------|-------------------------|
| 1000F | 1964-72 | Body Shims, 6 mm, 10 pc. set   | <b>MSRP \$12.00 set</b> |
| 1000D | 1964-72 | Body Shims, 3 mm, 10 pc. set   | <b>MSRP \$7.00 set</b>  |
| 1000E | 1966    | Body Shims, 1.6 mm, 10 pc. set | <b>MSRP \$7.00 set</b>  |
| GM03  |         | Body Washers, 20 pc. set       | <b>MSRP \$20.00 set</b> |

## Fender/Valance Brkt.



1704B 1964 Fender To Valance Bracket

**MSRP \$9.00 ea**

## Fender Brace Skirts

1702R



Reverse View

1702S



Reverse View

|       |     |      |                        |
|-------|-----|------|------------------------|
| 1702R | New | 1962 | Fender Brace Skirt, RH |
| 1702S | New | 1962 | Fender Brace Skirt, LH |

**MSRP \$87.00 ea**

## Inner Fenders

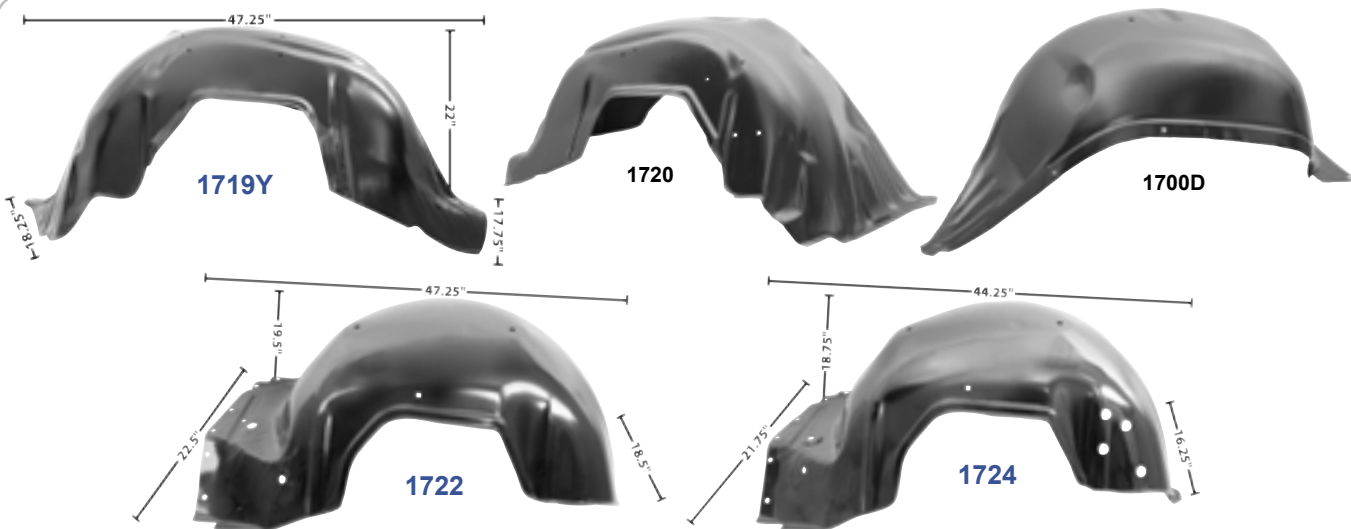

|       |     |      |                  |                         |
|-------|-----|------|------------------|-------------------------|
| 1719Y | New | 1962 | Inner Fender, RH | <b>MSRP \$209.00 ea</b> |
| 1719Z | New | 1962 | Inner Fender, LH | <b>MSRP \$209.00 ea</b> |
| 1720  |     | 1963 | Inner Fender, RH | <b>MSRP \$209.00 ea</b> |
| 1721  |     | 1963 | Inner Fender, LH | <b>MSRP \$209.00 ea</b> |
| 1700D |     | 1964 | Front Fender, RH | <b>MSRP \$190.00 ea</b> |
| 1700E |     | 1964 | Front Fender, LH | <b>MSRP \$190.00 ea</b> |
| 1722  | New | 1965 | Inner Fender, RH | <b>MSRP \$209.00 ea</b> |
| 1723  | New | 1965 | Inner Fender, LH | <b>MSRP \$209.00 ea</b> |
| 1724  | New | 1966 | Inner Fender, RH | <b>MSRP \$209.00 ea</b> |
| 1725  | New | 1966 | Inner Fender, LH | <b>MSRP \$209.00 ea</b> |



Wholesale Only. MSRP not including Taxes, Shipping and Handling. MSRP are subject to change without notice



**Radiator Supports**

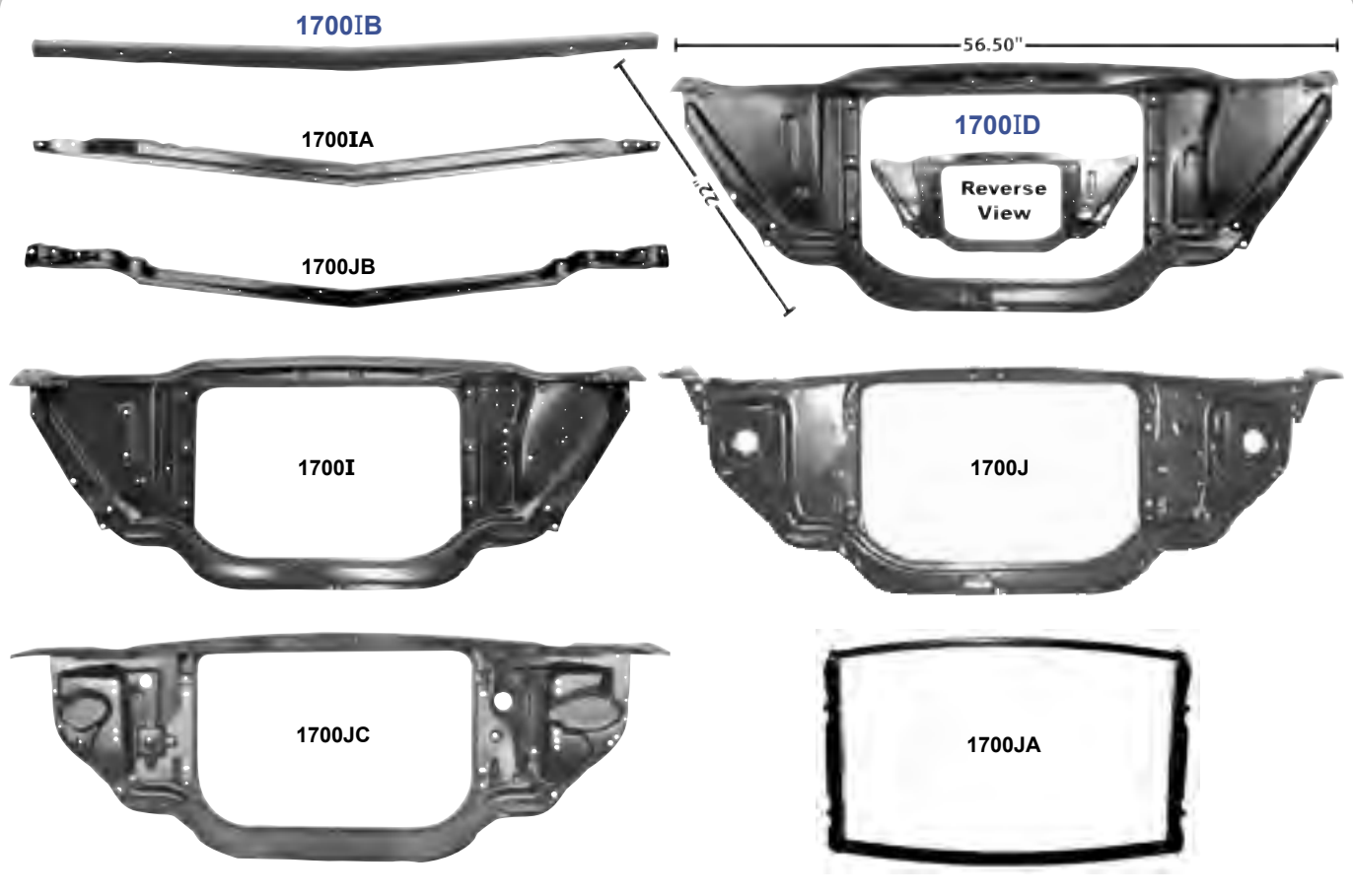

|        |     |         |                                                |                         |
|--------|-----|---------|------------------------------------------------|-------------------------|
| 1700ID | New | 1962    | Radiator Support                               | <b>MSRP \$267.00 ea</b> |
| 1700IB | New | 1962    | Upper Radiator Support                         | <b>MSRP \$107.00 ea</b> |
| 1700I  |     | 1963    | Radiator Support                               | <b>MSRP \$229.00 ea</b> |
| 1700IA |     | 1963    | Upper Radiator Support                         | <b>MSRP \$55.00 ea</b>  |
| 1700J  |     | 1964    | Radiator Support                               | <b>MSRP \$229.00 ea</b> |
| 1700JB |     | 1964    | Upper Radiator Support, Black                  | <b>MSRP \$55.00 ea</b>  |
| 1700JC |     | 1965    | Radiator Support                               | <b>MSRP \$285.00 ea</b> |
| 1700JA |     | 1965-66 | Radiator Support Frame, Black, For Small Block | <b>MSRP \$67.00 ea</b>  |

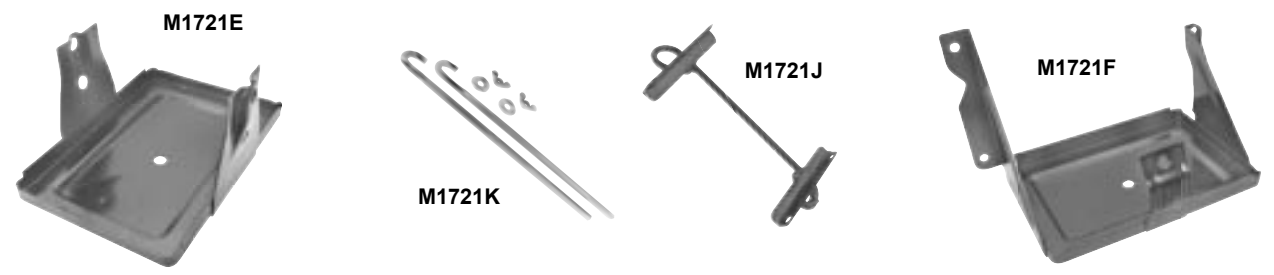

|        |  |         |                     |                        |
|--------|--|---------|---------------------|------------------------|
| M1721E |  | 1958    | Battery Tray        | <b>MSRP \$37.00 ea</b> |
| M1721J |  | 1957-58 | Battery Tray Clamp  | <b>MSRP \$10.00 ea</b> |
| M1721K |  | 1958    | Battery Clamp Bolts | <b>MSRP \$7.00 pr</b>  |
| M1721F |  | 1959-61 | Battery Tray        | <b>MSRP \$34.00 ea</b> |

**Battery Trays, etc.**

**Wholesale Only. MSRP not including Taxes, Shipping and Handling. MSRP are subject to change without notice**

## Battery Trays, Clamps & Bolts

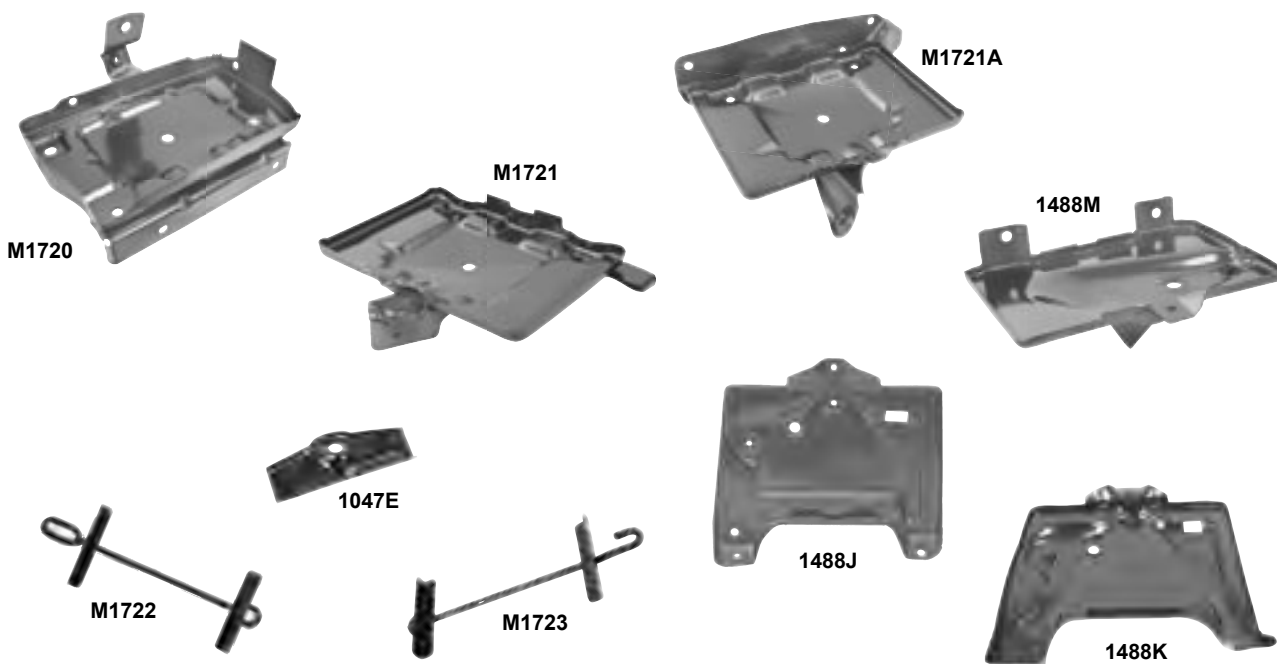

|        |         |                    |                        |
|--------|---------|--------------------|------------------------|
| M1720  | 1962-63 | Battery Tray       | <b>MSRP \$19.00 ea</b> |
| M1722  | 1962-63 | Battery Tray Clamp | <b>MSRP \$10.00 ea</b> |
| M1721  | 1964    | Battery Tray       | <b>MSRP \$19.00 ea</b> |
| M1723  | 1964    | Battery Tray Clamp | <b>MSRP \$12.00 ea</b> |
| M1721A | 1965    | Battery Tray       | <b>MSRP \$24.00 ea</b> |
| 1488M  | 1966    | Battery Tray       | <b>MSRP \$24.00 ea</b> |
| 1047E  | 1966-76 | Battery Tray Clamp | <b>MSRP \$5.00 ea</b>  |
| 1488J  | 1967    | Battery Tray       | <b>MSRP \$20.00 ea</b> |
| 1488K  | 1968-70 | Battery Tray       | <b>MSRP \$15.00 ea</b> |

## Washer Bottle Bracket



1425 1962-70 Windshield Washer Bottle Bracket

**MSRP \$15.00 ea**

## Outer Cowl Panels

1784



1785



1784 1962-64 Outer Cowl Panel, RH  
1785 1962-64 Outer Cowl Panel, LH

**MSRP \$65.00 ea**

Wholesale Only. MSRP not including Taxes, Shipping and Handling. MSRP are subject to change without notice



spooh

**Wholesale Only. MSRP not including Taxes, Shipping and Handling. MSRP are subject to change without notice**

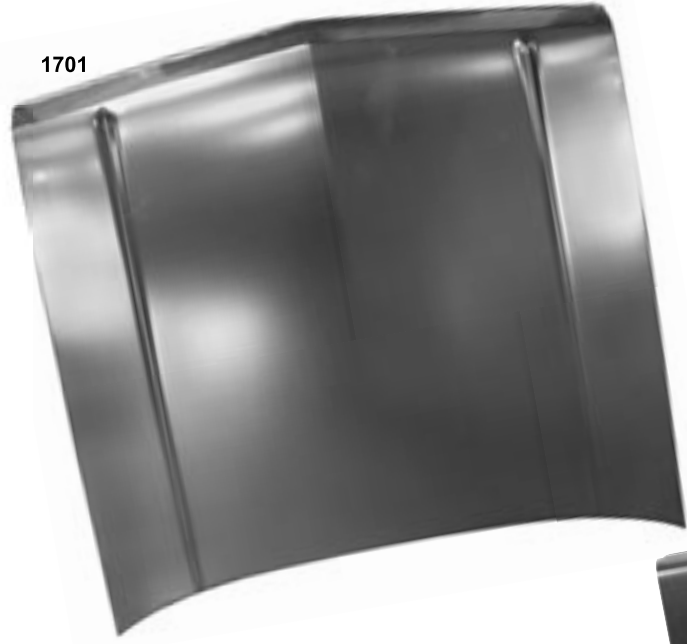

1701

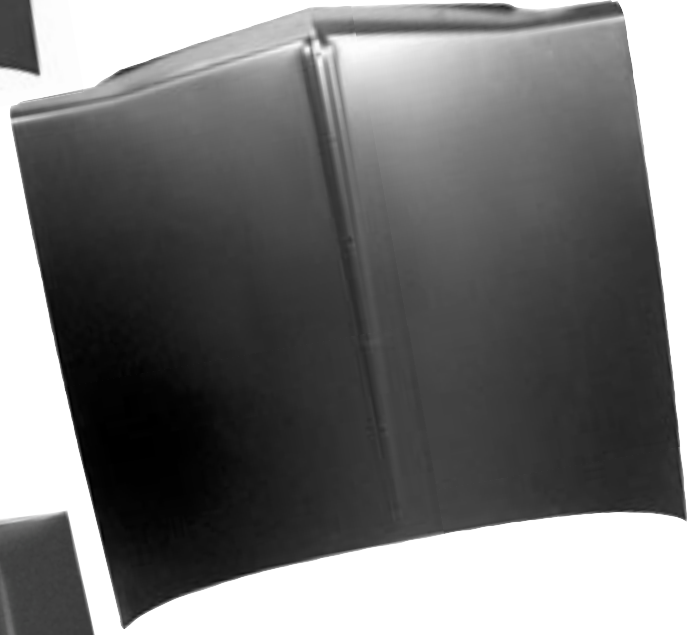

1702

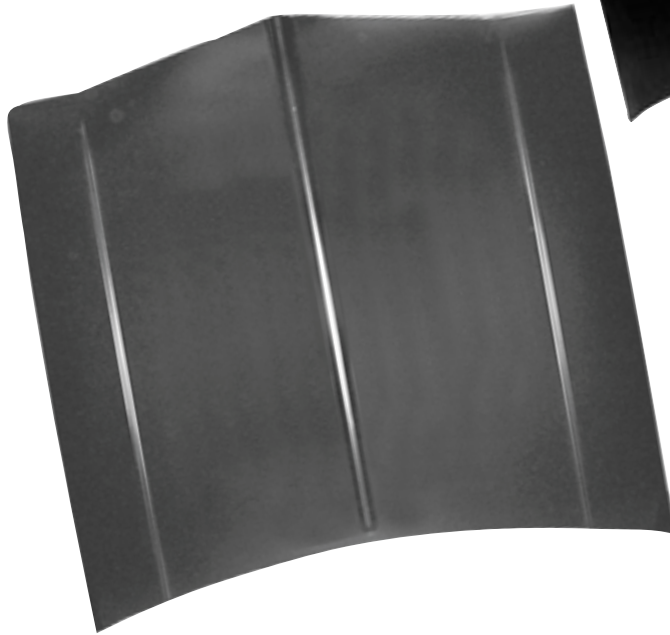

1706

|      |         |      |                  |
|------|---------|------|------------------|
| 1701 | 1963    | Hood | MSRP \$535.00 ea |
| 1702 | 1964    | Hood | MSRP \$535.00 ea |
| 1706 | 1965-66 | Hood | MSRP \$555.00 ea |

## Hood Hinges

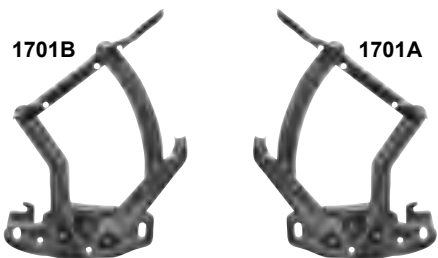

|                        |         |               |
|------------------------|---------|---------------|
| 1701A                  | 1963-64 | Hood Hinge RH |
| 1701B                  | 1963-64 | Hood Hinge LH |
| <b>MSRP \$55.00 ea</b> |         |               |

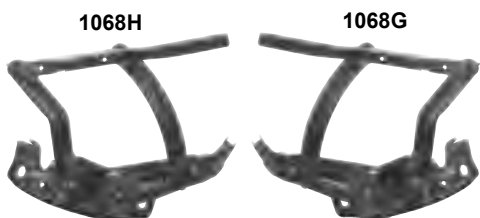

|                        |         |               |
|------------------------|---------|---------------|
| 1068G                  | 1965-67 | Hood Hinge RH |
| 1068H                  | 1965-67 | Hood Hinge LH |
| <b>MSRP \$55.00 ea</b> |         |               |



|                        |      |               |
|------------------------|------|---------------|
| 1464Y                  | 1968 | Hood Hinge RH |
| 1464Z                  | 1968 | Hood Hinge LH |
| <b>MSRP \$60.00 ea</b> |      |               |

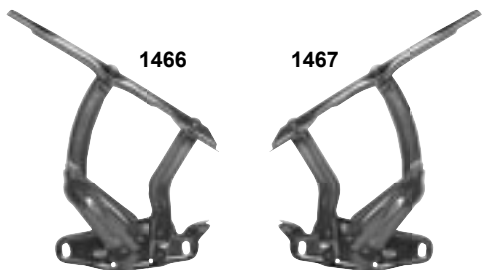

|                        |      |               |
|------------------------|------|---------------|
| 1466                   | 1970 | Hood Hinge RH |
| 1467                   | 1970 | Hood Hinge LH |
| <b>MSRP \$55.00 ea</b> |      |               |

## Hood Latches & Catch

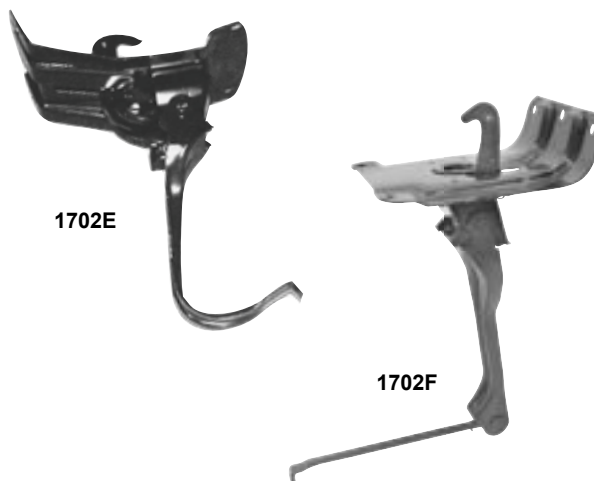

|                        |      |                     |
|------------------------|------|---------------------|
| 1702E                  | 1963 | Hood Latch Assembly |
| 1702F                  | 1964 | Hood Latch Assembly |
| <b>MSRP \$65.00 ea</b> |      |                     |

|                     |     |      |            |
|---------------------|-----|------|------------|
| 1701X               | New | 1962 | Hood Catch |
| <b>Coming Soon!</b> |     |      |            |

## Hood Latch Supports

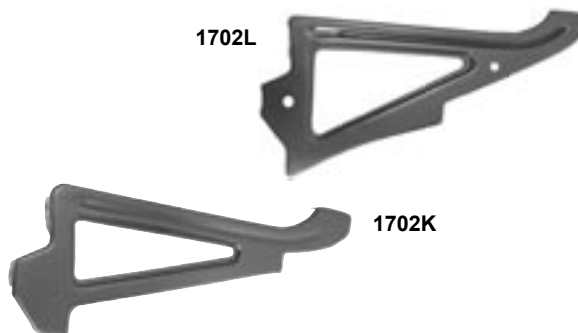

|                        |      |                    |
|------------------------|------|--------------------|
| 1702K                  | 1965 | Hood Latch Support |
| 1702L                  | 1966 | Hood Latch Support |
| <b>MSRP \$47.00 ea</b> |      |                    |

## Engine Mounts

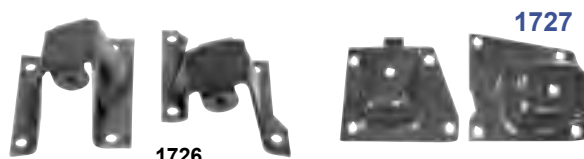

|                        |         |                      |
|------------------------|---------|----------------------|
| 1726                   | 1958-64 | Engine Mounts for V8 |
| <b>MSRP \$55.00 pr</b> |         |                      |

|                        |     |         |                              |
|------------------------|-----|---------|------------------------------|
| 1727                   | New | 1963-64 | Engine Mounts for 6 Cylinder |
| <b>MSRP \$35.00 pr</b> |     |         |                              |

Wholesale Only. MSRP not including Taxes, Shipping and Handling. MSRP are subject to change without notice



# IMPALA™



Wholesale Only. MSRP not including Taxes, Shipping and Handling. MSRP are subject to change without notice

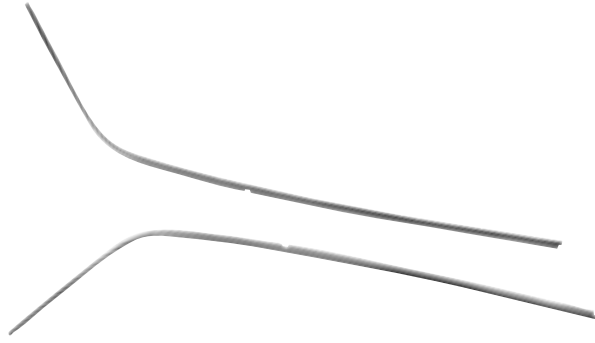

1795 New 1962-64 Roof Drip Rails  
MSRP \$170.00 pr

## Roof Drip Rails

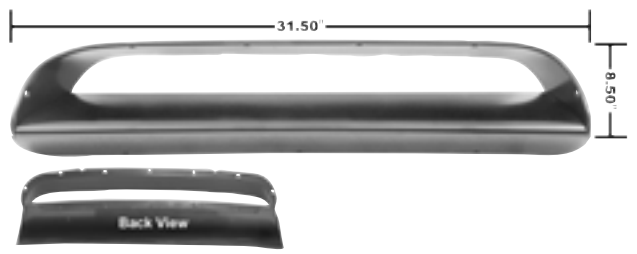

1728 New 1963-64 Steel Dash Panel  
MSRP \$220.00 ea

## Dash Panel



1700GX



1047F



1783

## Complete Floor Pan

|        |         |                                                              |                                                                                      |                   |
|--------|---------|--------------------------------------------------------------|--------------------------------------------------------------------------------------|-------------------|
| 1700GX | 1961-64 | Complete Floor Pan                                           |  | MSRP \$1320.00 ea |
| 1783   | 1965-70 | Complete Floor Pan w/braces, rocker panels and rear seat pan |                                                                                      | MSRP \$1520.00 ea |
| 1047F  | 1961-81 | Floor Pan Plug                                               |                                                                                      | MSRP \$5.00 ea    |

## Full Floor Pans

1700F



1783R



|       |         |                   |                         |
|-------|---------|-------------------|-------------------------|
| 1700F | 1961-64 | Full Floor Pan RH | <b>MSRP \$152.00 ea</b> |
| 1700G | 1961-64 | Full Floor Pan LH | <b>MSRP \$152.00 ea</b> |
| 1783R | 1965-70 | Floor Pan, RH     | <b>MSRP \$152.00 ea</b> |
| 1783L | 1965-70 | Floor Pan, LH     | <b>MSRP \$152.00 ea</b> |

## Rear Seat Pans

1780



1781



|      |         |                     |                         |
|------|---------|---------------------|-------------------------|
| 1780 | 1961-64 | Rear Seat Floor Pan | <b>MSRP \$114.00 ea</b> |
| 1781 | 1965-70 | Rear Seat Floor Pan | <b>MSRP \$114.00 ea</b> |

## Floor Pan Under Supports

1766A



1766F



|       |         |                       |
|-------|---------|-----------------------|
| 1766A | 1961-64 | Front Floor Pan Brace |
| 1766F | 1961-64 | Rear Floor Pan Brace  |

**MSRP \$107.00 ea**

1783A



1783B



1783C



|       |         |                                |
|-------|---------|--------------------------------|
| 1783A | 1965-70 | Front Floor Pan Under Support  |
| 1783B | 1965-70 | Center Floor Pan Under Support |
| 1783C | 1965-70 | Rear Floor Pan Under Support   |

**MSRP \$71.00 ea**

## Trans. Support



|       |     |         |                                  |
|-------|-----|---------|----------------------------------|
| 1766G | New | 1961-64 | Crossmember Transmission Support |
|-------|-----|---------|----------------------------------|

**MSRP \$85.00 ea**

## Side Under Supports

1783D

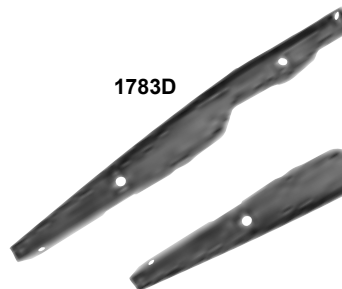

1783E

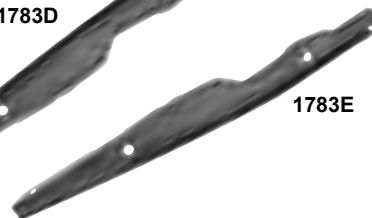

|       |         |                              |
|-------|---------|------------------------------|
| 1783D | 1965-70 | Floor Side Under Support, RH |
| 1783E | 1965-70 | Floor Side Under Support, LH |

**MSRP \$75.00 ea**

Wholesale Only. MSRP not including Taxes, Shipping and Handling. MSRP are subject to change without notice

Seat Platform Braces



|       |         |                                |                        |
|-------|---------|--------------------------------|------------------------|
| 1766B | 1961-64 | Pan Brace Under Front Seat, RH | <b>MSRP \$89.00 ea</b> |
| 1766C | 1961-64 | Pan Brace Under Front Seat, LH | <b>MSRP \$89.00 ea</b> |



|       |         |                               |                        |
|-------|---------|-------------------------------|------------------------|
| 1766D | 1961-64 | Pan Brace Under Rear Seat, RH | <b>MSRP \$74.00 ea</b> |
| 1766E | 1961-64 | Pan Brace Under Rear Seat, LH | <b>MSRP \$74.00 ea</b> |

Quarter "B" Pillar Panels

Rocker Panels

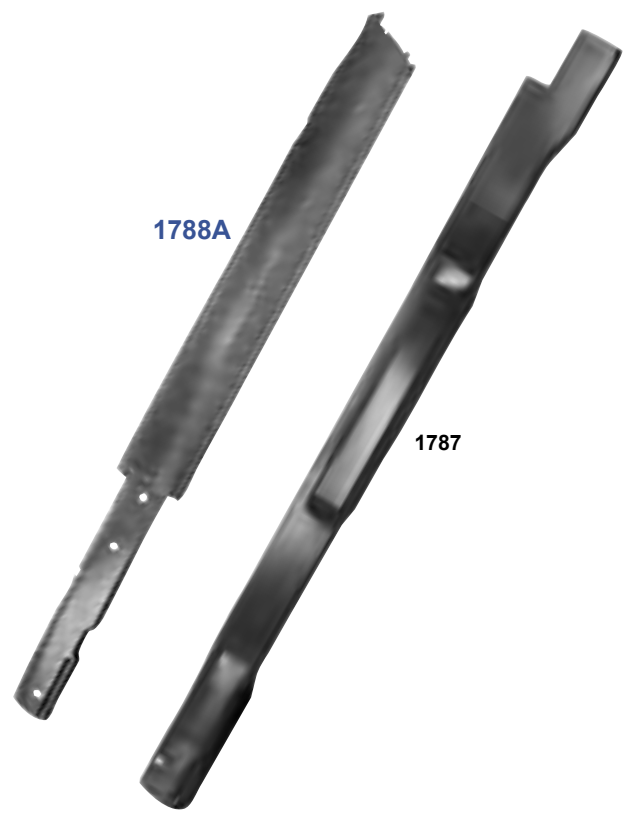

|                         |     |         |                        |
|-------------------------|-----|---------|------------------------|
| 1788                    | New | 1963    | Rocker Panel, RH       |
| 1789                    | New | 1963    | Rocker Panel, LH       |
| <b>Coming Soon!</b>     |     |         |                        |
| 1788A                   | New | 1964    | Rocker Panel, RH       |
| 1789A                   | New | 1964    | Rocker Panel, LH       |
| <b>MSRP \$227.00 ea</b> |     |         |                        |
| 1786                    |     | 1965-67 | Rocker Panel, Inner RH |
| 1787                    |     | 1965-67 | Rocker Panel, Inner LH |
| <b>MSRP \$85.00 ea</b>  |     |         |                        |



|                         |     |         |                              |
|-------------------------|-----|---------|------------------------------|
| 1733A                   | New | 1963-64 | Quarter "B" Pillar Panel, RH |
| 1733B                   | New | 1963-64 | Quarter "B" Pillar Panel, LH |
| <b>MSRP \$170.00 ea</b> |     |         |                              |

Wholesale Only. MSRP not including Taxes, Shipping and Handling. MSRP are subject to change without notice

## Seat Frame Assemblies

dii Exclusive

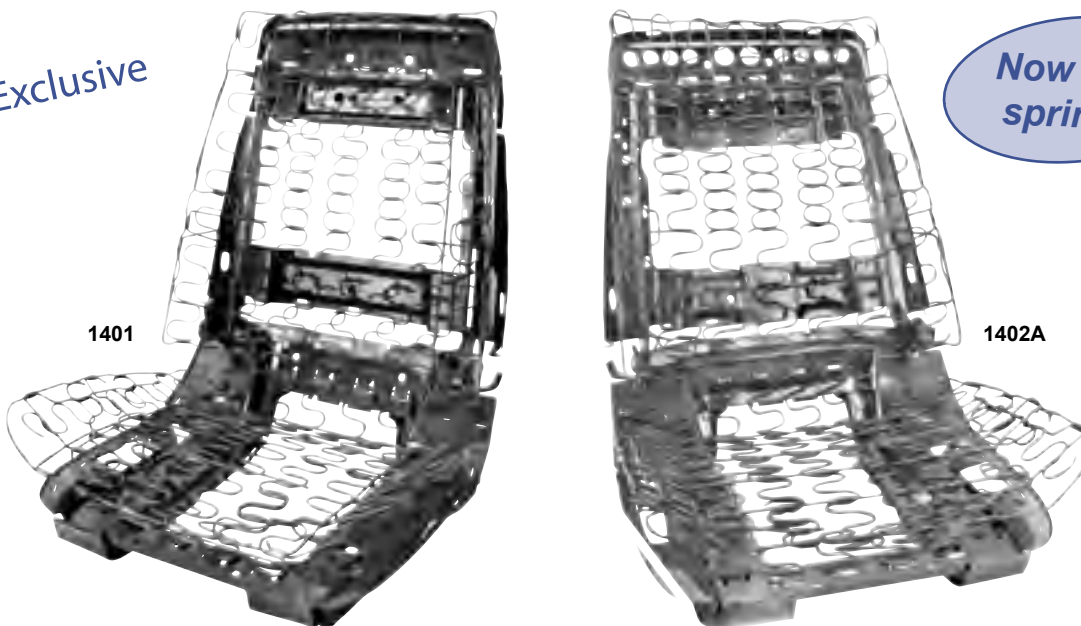

Now with  
springs!

|       |         |                                                 |                  |
|-------|---------|-------------------------------------------------|------------------|
| 1401  | 1966-68 | Seat Frame Assembly with Springs, RH            | MSRP \$509.00 ea |
| 1402  | 1966-68 | Seat Frame Assembly with Springs, LH            | MSRP \$509.00 ea |
| 1402A | 1969    | Seat Frame Assembly with Springs, Fits RH or LH | MSRP \$509.00 ea |

## Quarter Panels



|      |      |                   |                  |
|------|------|-------------------|------------------|
| 1730 | 1963 | Quarter Panel, RH | MSRP \$574.00 ea |
| 1731 | 1963 | Quarter Panel, LH | MSRP \$574.00 ea |
| 1732 | 1964 | Quarter Panel, RH | MSRP \$574.00 ea |
| 1733 | 1964 | Quarter Panel, LH | MSRP \$574.00 ea |

Wholesale Only. MSRP not including Taxes, Shipping and Handling. MSRP are subject to change without notice





Wheelhouses

Wholesale Only. MSRP not including Taxes, Shipping and Handling. MSRP are subject to change without notice.

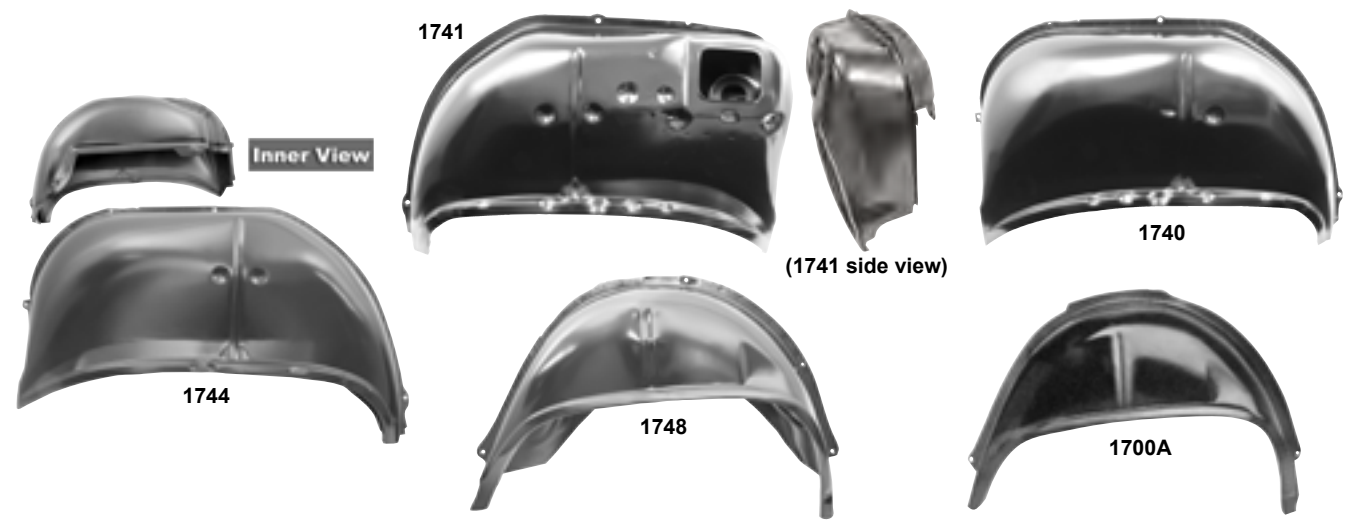

|       |         |                                             |                         |
|-------|---------|---------------------------------------------|-------------------------|
| 1744  | 1963    | Complete Wheelhouse (Inner/Outer), RH Coupe | <b>MSRP \$310.00 ea</b> |
| 1745  | 1963    | Complete Wheelhouse (Inner/Outer), LH Coupe | <b>MSRP \$324.00 ea</b> |
| 1740  | 1964    | Complete Wheelhouse (Inner/Outer), RH Coupe | <b>MSRP \$310.00 ea</b> |
| 1741  | 1964    | Complete Wheelhouse (Inner/Outer), LH Coupe | <b>MSRP \$324.00 ea</b> |
| 1700A | 1965-66 | Outer Wheelhouse, RH                        | <b>MSRP \$102.00 ea</b> |
| 1700B | 1965-66 | Outer Wheelhouse, LH                        | <b>MSRP \$102.00 ea</b> |
| 1748  | 1965-66 | Complete Wheelhouse (Inner/Outer), RH       | <b>MSRP \$310.00 ea</b> |
| 1749  | 1965-66 | Complete Wheelhouse (Inner/Outer), LH       | <b>MSRP \$310.00 ea</b> |

Wheelhouse Braces

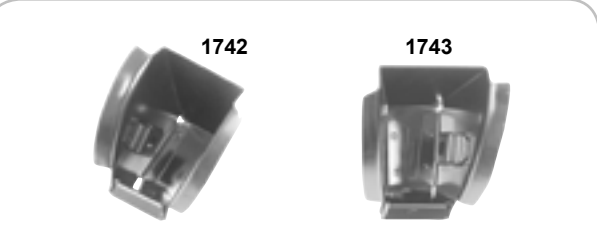

|                        |         |                           |
|------------------------|---------|---------------------------|
| 1742                   | 1961-64 | Rear Wheelhouse Brace, RH |
| 1743                   | 1961-64 | Rear Wheelhouse Brace, LH |
| <b>MSRP \$50.00 ea</b> |         |                           |



|                        |         |                                         |
|------------------------|---------|-----------------------------------------|
| 1746                   | 1963-64 | Wheelhouse to Rocker Brace, RH          |
| 1747                   | 1963-64 | Wheelhouse to Rocker Brace, LH          |
| <b>MSRP \$22.00 ea</b> |         |                                         |
| 1746A                  | New     | 1963-64 Wheelhouse to Quarter Brace, RH |
| 1746B                  | New     | 1963-64 Wheelhouse to Quarter Brace, LH |
| <b>MSRP \$42.00 ea</b> |         |                                         |

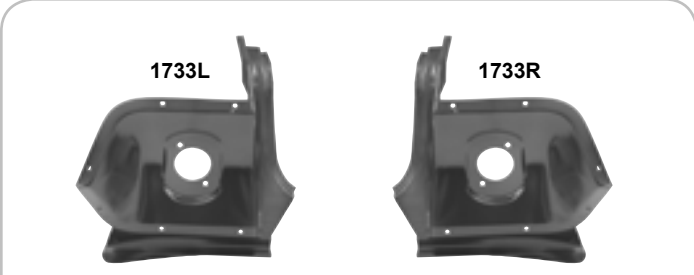

|                        |      |                               |
|------------------------|------|-------------------------------|
| 1733R                  | 1963 | Tail Light Mounting Panel, RH |
| 1733L                  | 1963 | Tail Light Mounting Panel, LH |
| <b>MSRP \$85.00 ea</b> |      |                               |



|                        |      |                               |
|------------------------|------|-------------------------------|
| 1734R                  | 1964 | Tail Light Mounting Panel, RH |
| 1734L                  | 1964 | Tail Light Mounting Panel, LH |
| <b>MSRP \$80.00 ea</b> |      |                               |

Tail Light Mtng. Panels

## Deck Lid Filler Panel



1771B 1964 Deck Lid Filler Panel  
**MSRP \$265.00 ea**

## Lic. Plate Brkt. Gas Filler Door



GM Restoration Parts

1738 1964 Gas Filler Door  
**MSRP \$65.00 ea**



1700Z 1965 License Plate Bracket  
**MSRP \$64.00 ea**

## Gas Tanks



T29



T25

|     |         |                     |                         |
|-----|---------|---------------------|-------------------------|
| T29 | 1961-64 | Galvanized Gas Tank | <b>MSRP \$170.00 ea</b> |
| T25 | 1965-67 | Galvanized Gas Tank | <b>MSRP \$165.00 ea</b> |

## Tank Straps / Braces



T25A



1767

|      |         |                                    |                        |
|------|---------|------------------------------------|------------------------|
| T25A | 1961-64 | Gas Tank Straps w/o bolts, 2 piece | <b>MSRP \$24.00 ea</b> |
| T25B | 1965-70 | Gas Tank Straps w/o bolts, 2 piece | <b>MSRP \$24.00 ea</b> |
| 1767 | 1965-70 | Gas Tank Brace, Fits RH or LH      | <b>MSRP \$72.00 ea</b> |

Wholesale Only. MSRP not including Taxes, Shipping and Handling. MSRP are subject to change without notice

## Fuel Sending Units

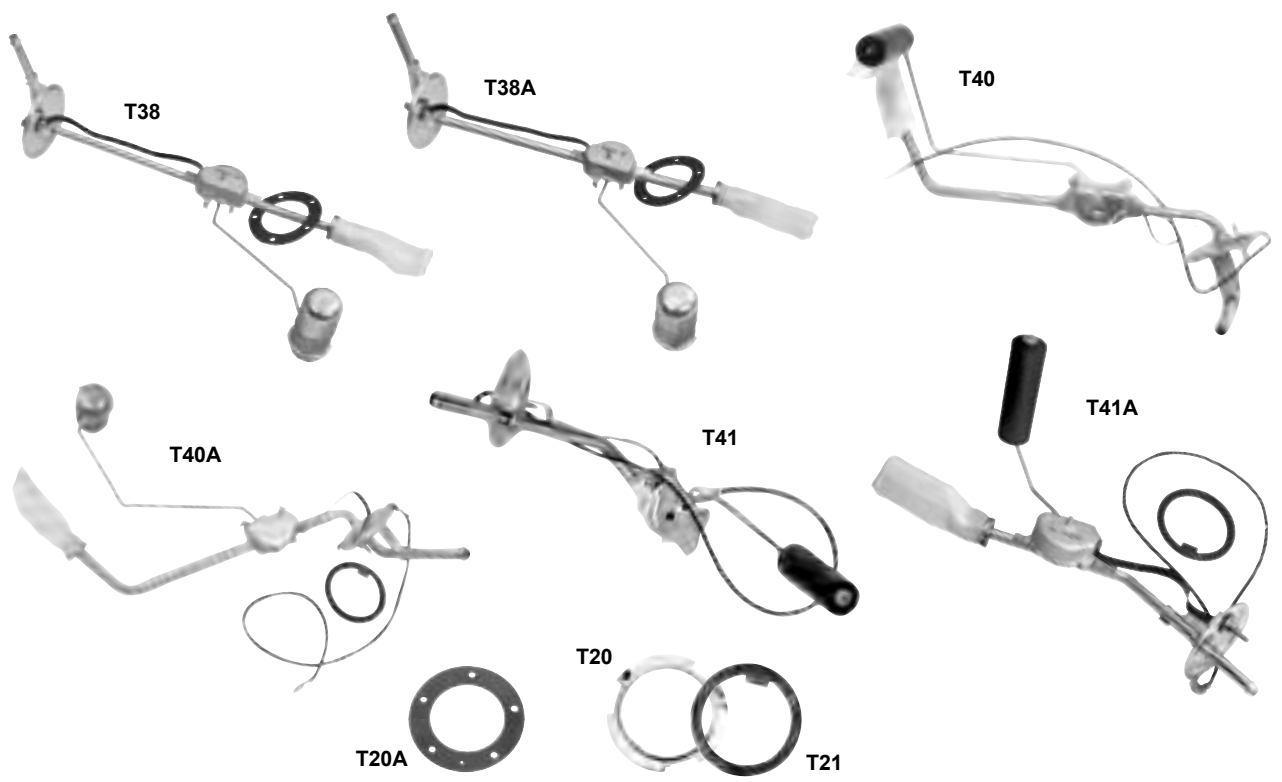

|      |         |                                        |                        |
|------|---------|----------------------------------------|------------------------|
| T38  | 1958-60 | Fuel Sending Unit, 5/16"               | <b>MSRP \$49.00 ea</b> |
| T38A | 1958-60 | Fuel Sending Unit, 3/8"                | <b>MSRP \$49.00 ea</b> |
| T40  | 1961-64 | Fuel Sending Unit, 5/16"               | <b>MSRP \$59.00 ea</b> |
| T40A | 1961-64 | Fuel Sending Unit, 3/8"                | <b>MSRP \$50.00 ea</b> |
| T41  | 1965-70 | Fuel Sending Unit, 3/8" (Small Flange) | <b>MSRP \$62.00 ea</b> |
| T41A | 1965-67 | Fuel Sending Unit, 5/16"               | <b>MSRP \$50.00 ea</b> |
| T20  | 1961-81 | Fuel Sending Unit Locking Ring         | <b>MSRP \$4.00 ea</b>  |
| T20A | 1958-60 | Fuel Sending Unit Gasket               | <b>MSRP \$4.00 ea</b>  |
| T21  | 1961-81 | Fuel Sending Unit Gasket               | <b>MSRP \$4.00 ea</b>  |

**Wholesale Only. MSRP not including Taxes, Shipping and Handling. MSRP are subject to change without notice.**



|       |         |                  |                         |
|-------|---------|------------------|-------------------------|
| 1781Z | 1965    | Tail Panel Brace | <b>MSRP \$152.00 ea</b> |
| 1782  | 1966-70 | Tail Panel Brace | <b>MSRP \$167.00 ea</b> |

## Tail Panel Brace



|      |      |                         |                        |
|------|------|-------------------------|------------------------|
| 1760 | 1963 | Rear Body Panel, 4 pcs. | <b>MSRP \$94.00 ea</b> |
| 1761 | 1964 | Rear Body Panel, 4 pcs. | <b>MSRP \$94.00 ea</b> |

## Rear Body Panels

## Trunk Lids



1770



1771



1771A



|       |      |                                              |                         |
|-------|------|----------------------------------------------|-------------------------|
| 1770  | 1963 | Trunk Lid, Impala                            | <b>MSRP \$585.00 ea</b> |
| 1771  | 1964 | Trunk Lid, Impala (4 lamp holes)             | <b>MSRP \$585.00 ea</b> |
| 1771A | 1964 | Trunk Lid, Biscayne & Bel Air (2 lamp holes) | <b>MSRP \$585.00 ea</b> |

## Trunk Lid Latch



1772 1959-72 Trunk Lid Latch  
**MSRP \$42.00 ea**

## Cross Rail



1769 1961-64 Trunk Cross Rail Panel Excludes Wagon  
**MSRP \$87.00 ea**

## Divider Panel



1781A 1965-70 Trunk Divider Panel  
**MSRP \$94.00 ea**

Wholesale Only. MSRP not including Taxes, Shipping and Handling. MSRP are subject to change without notice



Wholesale Only. MSRP not including Taxes, Shipping and Handling. MSRP are subject to change without notice



|                         |         |                   |
|-------------------------|---------|-------------------|
| 1781B                   | 1961-64 | Trunk Shelf Panel |
| <b>MSRP \$574.00 ea</b> |         |                   |

## Trunk Shelf Panel



|                        |         |                         |
|------------------------|---------|-------------------------|
| 1764                   | 1965-70 | Trunk Floor Pan, RH     |
| <b>MSRP \$85.00 ea</b> |         |                         |
| 1762                   | 1965-70 | Trunk Floor Pan, Center |
| <b>MSRP \$69.00 ea</b> |         |                         |
| 1765                   | 1965-70 | Trunk Floor Pan, LH     |
| <b>MSRP \$85.00 ea</b> |         |                         |

## Trunk Floor Panels



|       |         |                          |
|-------|---------|--------------------------|
| 1700H | 1961-64 | Trunk Lower Pan 2/4 door |
|-------|---------|--------------------------|



|        |         |                         |                         |
|--------|---------|-------------------------|-------------------------|
| 1700HA | 1963-64 | Trunk Floor Outer Panel | <b>MSRP \$114.00 ea</b> |
|--------|---------|-------------------------|-------------------------|



|        |      |                               |                         |
|--------|------|-------------------------------|-------------------------|
| 1700HB | 1963 | Trunk Floor w/Pan & Drop Offs | <b>MSRP \$572.00 ea</b> |
|--------|------|-------------------------------|-------------------------|

## Trunk Floor Pans



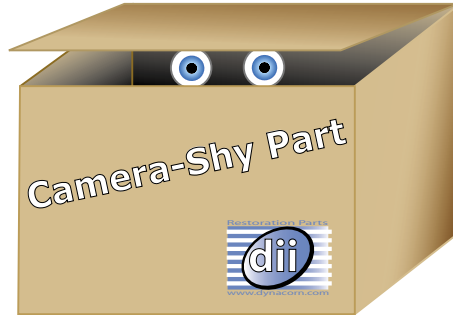

1700HC New 1964 Trunk Floor w/Pan & Drop Offs MSRP \$572.00 ea



1700HD



Underside View

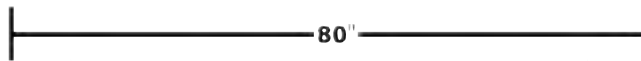

80"



76.5"



76"



*Does Not Qualify For Free Freight Program  
\* Special Order Only- Call for Availability \**

1700HD 1963 Trunk Floor Pan w/ Shelf Panel and Wheelhouses MSRP \$2400.00 ea

Wholesale Only. MSRP not including Taxes, Shipping and Handling. MSRP are subject to change without notice

**Wholesale Only. MSRP not including Taxes, Shipping and Handling. MSRP are subject to change without notice.**

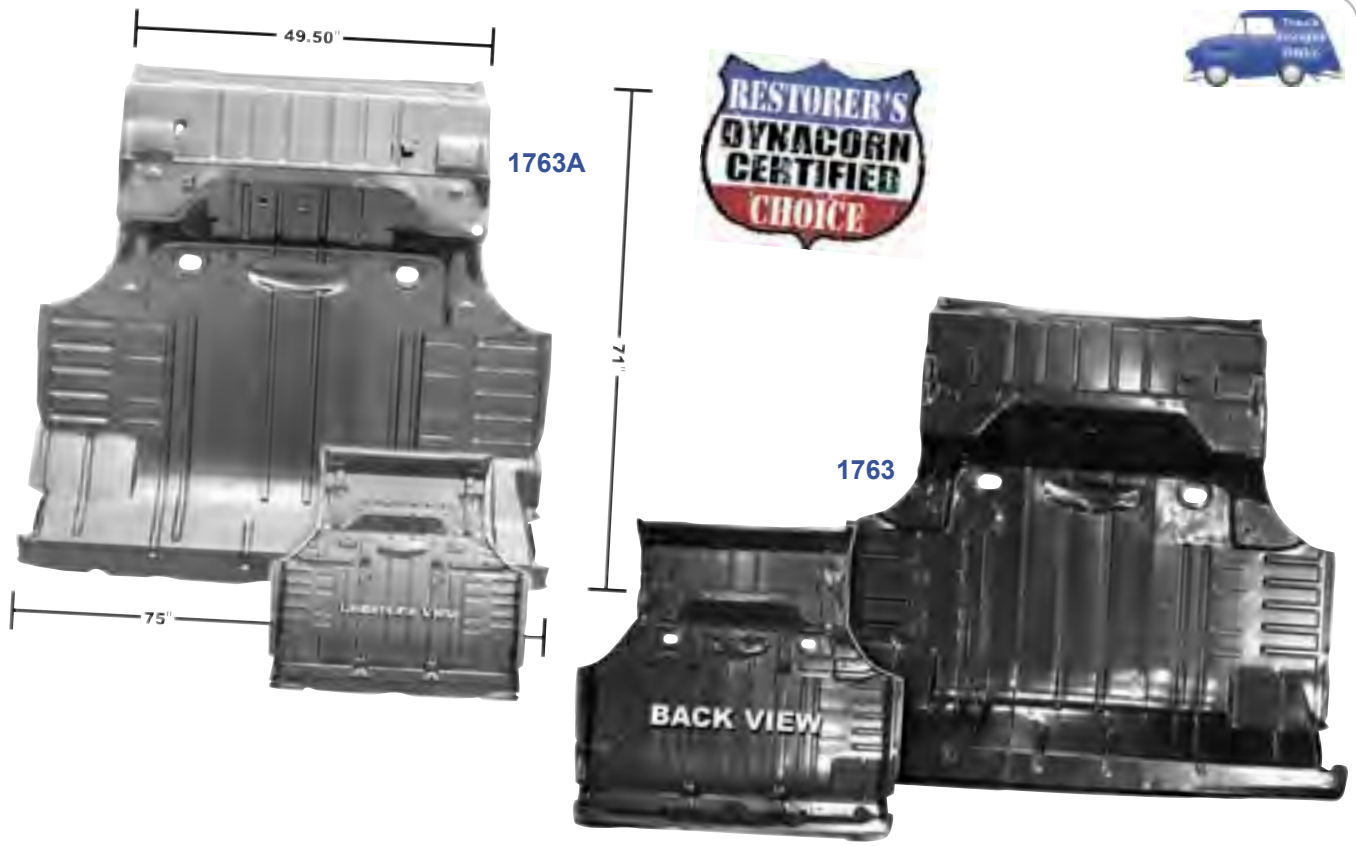

|       |     |      |                                                                |                          |
|-------|-----|------|----------------------------------------------------------------|--------------------------|
| 1763A | New | 1965 | Trunk Floor/divider panel with tank mounts, braces & drop offs | <b>MSRP \$1530.00 ea</b> |
| 1763  | New | 1966 | Trunk Floor/divider panel with tank mounts, braces & drop offs | <b>MSRP \$1530.00 ea</b> |

**Trunk Floor**

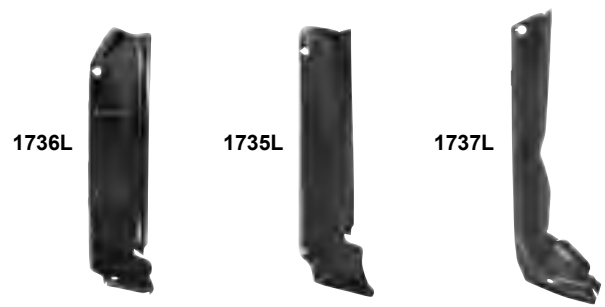

|                        |         |                          |
|------------------------|---------|--------------------------|
| 1736R                  | 1963    | Trunk Floor Drop Off, RH |
| 1736L                  | 1963    | Trunk Floor Drop Off, LH |
| <b>MSRP \$65.00 ea</b> |         |                          |
| 1735R                  | 1964    | Trunk Floor Drop Off, RH |
| 1735L                  | 1964    | Trunk Floor Drop Off, LH |
| <b>MSRP \$65.00 ea</b> |         |                          |
| 1737R                  | 1965-70 | Trunk Floor Drop Off, RH |
| 1737L                  | 1965-70 | Trunk Floor Drop Off, LH |
| <b>MSRP \$69.00 ea</b> |         |                          |

**Trunk Floor Drop Offs**



|                        |         |                             |
|------------------------|---------|-----------------------------|
| 1768R                  | 1965-70 | Trunk Floor Under Brace, RH |
| 1768L                  | 1965-70 | Trunk Floor Under Brace, LH |
| <b>MSRP \$50.00 ea</b> |         |                             |
| 1766R                  | 1965-70 | Trunk Floor Side Brace, RH  |
| 1766L                  | 1965-70 | Trunk Floor Side Brace, LH  |
| <b>MSRP \$47.00 ea</b> |         |                             |

**Under Braces**

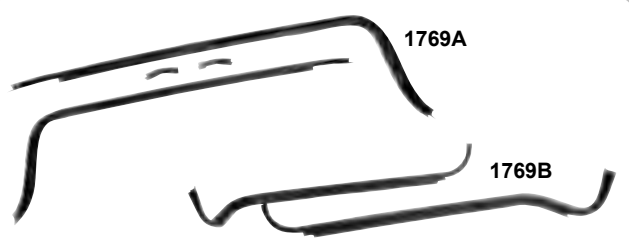

|                         |         |                            |
|-------------------------|---------|----------------------------|
| 1769A                   | 1962    | Trunk Weatherstrip Channel |
| 1769B                   | 1963-64 | Trunk Weatherstrip Channel |
| <b>MSRP \$229.00 pr</b> |         |                            |

**Weatherstrip Channel**

## Door Shells



1750



1751A



|       |      |                |                         |
|-------|------|----------------|-------------------------|
| 1750  | 1963 | Door Shell, RH | <b>MSRP \$630.00 ea</b> |
| 1751  | 1963 | Door Shell, LH | <b>MSRP \$630.00 ea</b> |
| 1751A | 1964 | Door Shell, RH | <b>MSRP \$630.00 ea</b> |
| 1751B | 1964 | Door Shell, LH | <b>MSRP \$630.00 ea</b> |

## Door Glass Assemblies

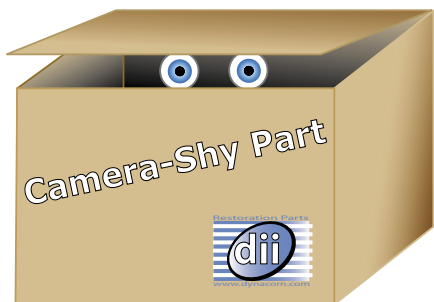

Camera-Shy Part



|       |     |         |                         |
|-------|-----|---------|-------------------------|
| 1751G | New | 1962-64 | Door Glass Assembly, RH |
| 1751H | New | 1962-64 | Door Glass Assembly, LH |

**MSRP \$535.00 ea**

## Door Window Frames

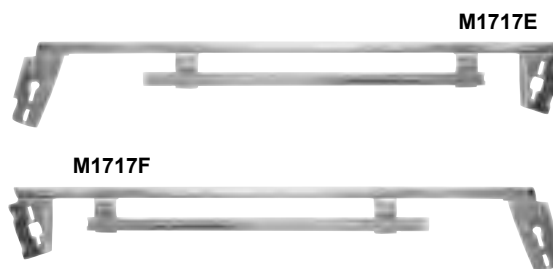

M1717E

M1717F

|        |         |                             |
|--------|---------|-----------------------------|
| M1717E | 1961-64 | Door Window Lower Frame, RH |
| M1717F | 1961-64 | Door Window Lower Frame, LH |

**MSRP \$75.00 ea**

## Door Hinges



1756

1758

1759

|      |         |                            |
|------|---------|----------------------------|
| 1756 | 1962-64 | Upper Door Hinge, RH or LH |
| 1758 | 1962-64 | Lower Door Hinge, RH       |
| 1759 | 1962-64 | Lower Door Hinge, LH       |

**MSRP \$114.00 ea**

**MSRP \$132.00 ea**

Wholesale Only. MSRP not including Taxes, Shipping and Handling. MSRP are subject to change without notice





Wholesale Only. MSRP not including Taxes, Shipping and Handling. MSRP are subject to change without notice

## Door Latches & Striker

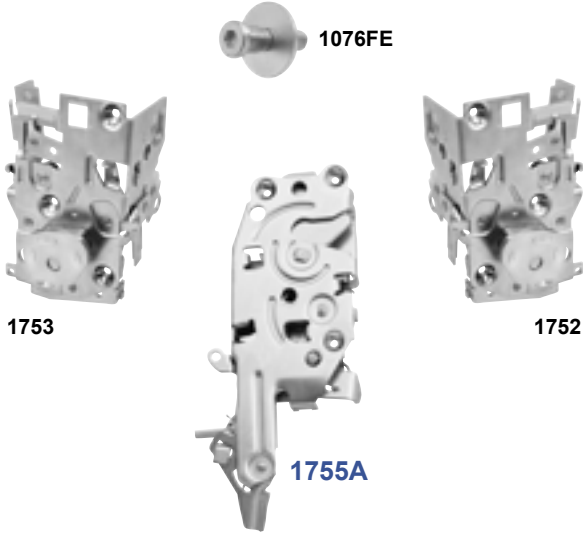

|        |             |                   |                         |
|--------|-------------|-------------------|-------------------------|
| 1752   | 1963        | Door Latch, RH    | <b>MSRP \$112.00 ea</b> |
| 1753   | 1963        | Door Latch, LH    | <b>MSRP \$112.00 ea</b> |
| 1754   | New 1964    | Door Latch, RH    | <b>MSRP \$112.00 ea</b> |
| 1755   | New 1964    | Door Latch, LH    | <b>MSRP \$112.00 ea</b> |
| 1076FE | 1964-70     | Door Lock Striker | <b>MSRP \$17.00 ea</b>  |
| 1755A  | New 1965-66 | Door Latch, RH    | <b>MSRP \$97.00 ea</b>  |
| 1755B  | New 1965-66 | Door Latch, LH    | <b>MSRP \$97.00 ea</b>  |

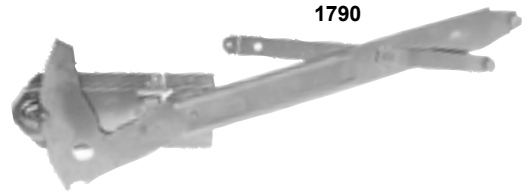

|                         |         |                      |
|-------------------------|---------|----------------------|
| 1790                    | 1961-64 | Window Regulator, RH |
| 1791                    | 1961-64 | Window Regulator, LH |
| <b>MSRP \$100.00 ea</b> |         |                      |

1751C



1751F

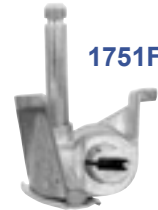

|                        |     |         |                          |
|------------------------|-----|---------|--------------------------|
| 1751C                  | New | 1962-64 | Vent Window Actuator, RH |
| 1751D                  | New | 1962-64 | Vent Window Actuator, LH |
| <b>MSRP \$94.00 ea</b> |     |         |                          |
| 1751E                  | New | 1965    | Vent Window Actuator, RH |
| 1751F                  | New | 1965    | Vent Window Actuator, LH |
| <b>MSRP \$94.00 ea</b> |     |         |                          |

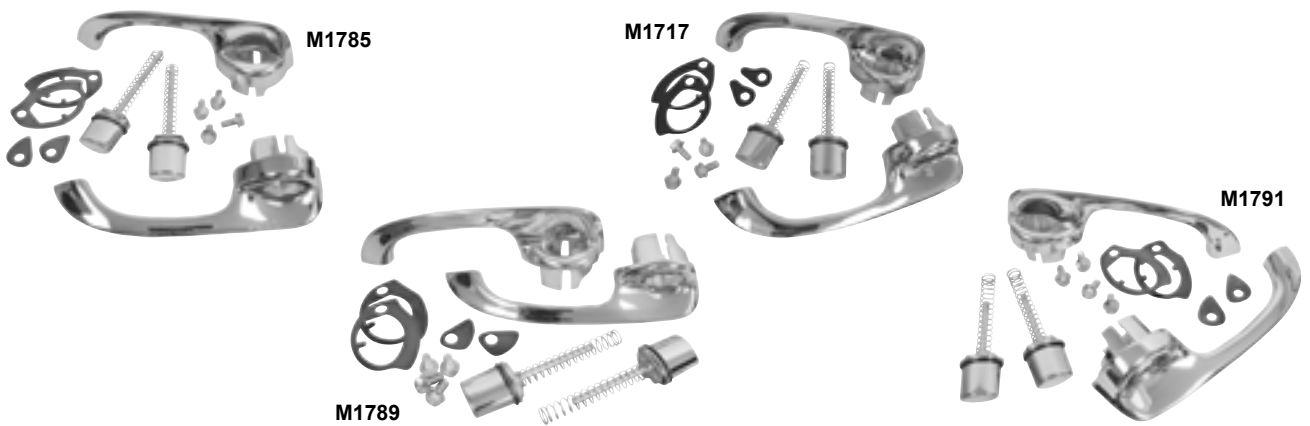

|       |         |                                           |                        |
|-------|---------|-------------------------------------------|------------------------|
| M1785 | 1960    | Exterior Door Handles, For 2 door         | <b>MSRP \$62.00 pr</b> |
| M1786 | 1960    | Exterior Front Door Handles, For 4 door   | <b>MSRP \$62.00 pr</b> |
| M1787 | 1960    | Exterior Rear Door Handles, For 4 door    | <b>MSRP \$62.00 pr</b> |
| M1716 | 1961-62 | Exterior Front Door Handles, For 2/4 door | <b>MSRP \$62.00 pr</b> |
| M1789 | 1961-62 | Exterior Rear Door Handles, For 4 door    | <b>MSRP \$62.00 pr</b> |
| M1717 | 1963-64 | Exterior Front Door Handles, For 2/4 door | <b>MSRP \$62.00 pr</b> |
| M1791 | 1963-64 | Exterior Rear Door Handles, For 4 door    | <b>MSRP \$62.00 pr</b> |

Window Regulators

Vent Window Actuator

Exterior Door Handles

## Exterior Door Handles, cont'd.

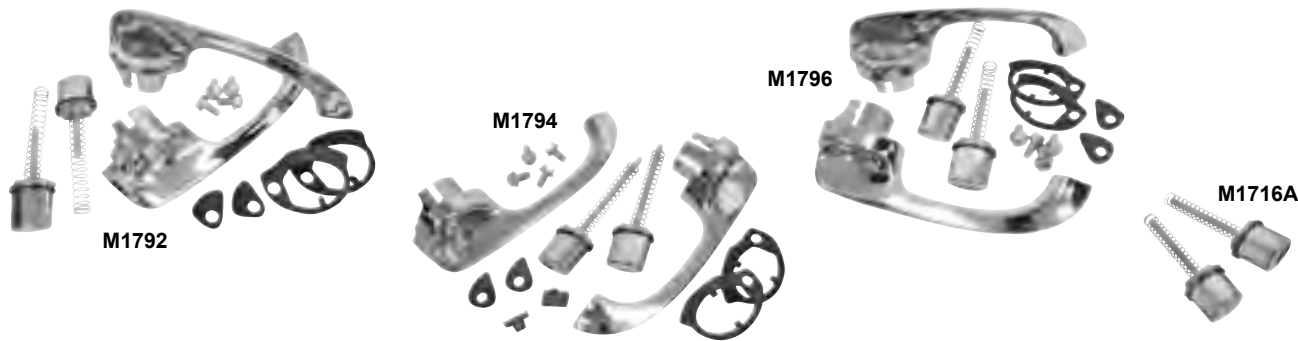

|        |         |                                         |                        |
|--------|---------|-----------------------------------------|------------------------|
| M1792  | 1965-68 | Exterior Door Handles, For 2 door       | <b>MSRP \$62.00 pr</b> |
| M1793  | 1965-68 | Exterior Front Door Handles, For 4 door | <b>MSRP \$62.00 pr</b> |
| M1794  | 1965-68 | Exterior Rear Door Handles, For 4 door  | <b>MSRP \$62.00 pr</b> |
| M1795  | 1969-70 | Exterior Door Handles, For 2 door       | <b>MSRP \$62.00 pr</b> |
| M1796  | 1969-70 | Exterior Front Door Handles, For 4 door | <b>MSRP \$62.00 pr</b> |
| M1797  | 1969-70 | Exterior Rear Door Handles, For 4 door  | <b>MSRP \$62.00 pr</b> |
| M1716A | 1961-62 | Door Handle Push Button Kit             | <b>MSRP \$10.00 pr</b> |
| M1717A | 1963-64 | Door Handle Push Button Kit             | <b>MSRP \$10.00 pr</b> |

## Interior Door Handles

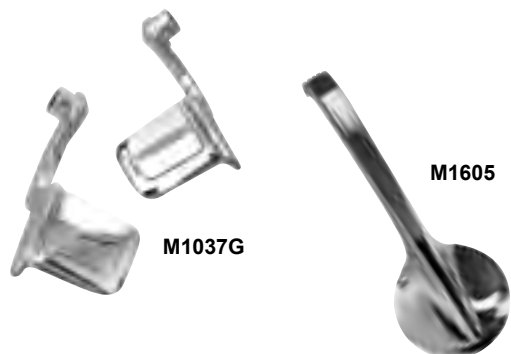

|       |         |                                  |                        |
|-------|---------|----------------------------------|------------------------|
| M1605 | 1958-64 | Interior Door Handle, Single Arm | <b>MSRP \$15.00 ea</b> |
|-------|---------|----------------------------------|------------------------|

|        |         |                       |                        |
|--------|---------|-----------------------|------------------------|
| M1037G | 1959-67 | Interior Door Handles | <b>MSRP \$35.00 pr</b> |
|--------|---------|-----------------------|------------------------|



|        |         |                                   |                        |
|--------|---------|-----------------------------------|------------------------|
| M1037D | 1968-70 | Interior Standard Door Handle, RH | <b>MSRP \$22.00 ea</b> |
| M1037E | 1968-70 | Interior Standard Door Handle, LH |                        |

## Vent Window Cranks



|        |         |                                           |
|--------|---------|-------------------------------------------|
| M1392H | 1958-64 | Single Arm Vent Window Crank, Chrome Knob |
| M1392G | 1958-60 | Single Arm Vent Window Crank, Black Knob  |

**MSRP \$15.00 ea**

|        |         |                                           |
|--------|---------|-------------------------------------------|
| M1392F | 1959-64 | Double Arm Vent Window Crank, Chrome Knob |
| M1392E | 1961-64 | Double Arm Vent Window Crank, Black Knob  |

**MSRP \$15.00 ea**

|        |         |                                         |
|--------|---------|-----------------------------------------|
| M1392M | 1965-66 | Vent Window Crank, Chrome Knob          |
| M1392L | 1965-66 | Vent Window Crank, Biscayne, Black Knob |
| M1392N | 1967    | Vent Window Crank, Black Knob           |

**MSRP \$17.00 ea**

Wholesale Only. MSRP not including Taxes, Shipping and Handling. MSRP are subject to change without notice



Wholesale Only. MSRP not including Taxes, Shipping and Handling. MSRP are subject to change without notice.



|        |         |                                        |                        |
|--------|---------|----------------------------------------|------------------------|
| M1392C | 1958-64 | Single Arm Window Crank, Charcoal Knob | <b>MSRP \$14.00 ea</b> |
| M1392D | 1958-64 | Single Arm Window Crank, Chrome Knob   | <b>MSRP \$14.00 ea</b> |
| M1392B | 1961-64 | Double Arm Window Crank, Chrome Knob   | <b>MSRP \$14.00 ea</b> |
| M1392A | 1961-64 | Double Arm Window Crank, Black Knob    | <b>MSRP \$14.00 ea</b> |
| M1776  | 1965-66 | Window Crank, Biscayne Black knob      | <b>MSRP \$25.00 ea</b> |

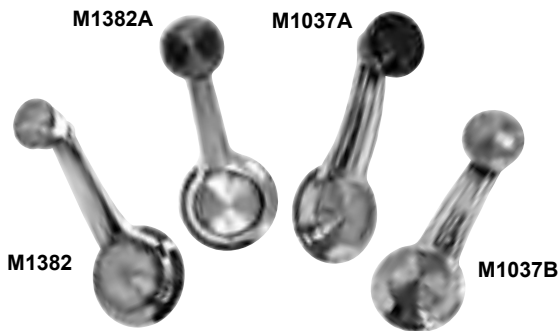

|        |         |                           |                        |
|--------|---------|---------------------------|------------------------|
| M1382  | 1965-66 | Window Crank, Chrome Knob | <b>MSRP \$25.00 ea</b> |
| M1382A | 1967    | Window Crank, Black Knob  | <b>MSRP \$25.00 ea</b> |
| M1037A | 1968    | Window Crank, Black Knob  | <b>MSRP \$5.00 ea</b>  |
| M1037B | 1969-70 | Window Crank, Clear Knob  | <b>MSRP \$5.00 ea</b>  |

## Window Cranks



|         |      |                              |                                  |
|---------|------|------------------------------|----------------------------------|
| B221000 | 1961 | Upper Door Molding, RH       | <b>MSRP \$32.00 ea</b>           |
| B220500 | 1961 | Upper Door Molding, LH       | <b>MSRP \$32.00 ea</b>           |
| B221500 | 1961 | Lower Door Molding, RH/LH    | <b>MSRP \$32.00 ea</b>           |
| B227500 | 1964 | Upper Door Mldg, RH/LH       | 2 Door<br><b>MSRP \$50.00 ea</b> |
| B229580 | 1964 | Upper Front Door Mldg, RH/LH | 4 Door<br><b>MSRP \$42.00 ea</b> |
| B229585 | 1964 | Upper Rear Door Mldg, RH/LH  | 4 Door<br><b>MSRP \$42.00 ea</b> |
| B231635 | 1966 | Door Mldg, RH/LH             | 2 Door<br><b>MSRP \$69.00 ea</b> |

## Door Molding



|       |         |                         |                       |
|-------|---------|-------------------------|-----------------------|
| M1770 | 1961-66 | Door Lock Knobs, Black  | <b>MSRP \$5.00 pr</b> |
| M1771 | 1961-66 | Door Lock Knobs, Chrome | <b>MSRP \$5.00 pr</b> |
| M1772 | 1967    | Door Lock Knobs, Black  | <b>MSRP \$5.00 pr</b> |
| M1773 | 1967    | Door Lock Knobs, Chrome | <b>MSRP \$5.00 pr</b> |
| M1777 | 1968    | Door Lock Knobs, Black  | <b>MSRP \$5.00 pr</b> |

## Door Lock Knobs

## Arm Rest Bases

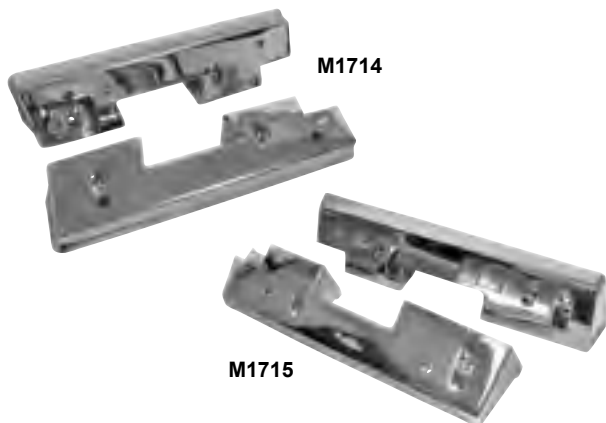

|       |         |                        |
|-------|---------|------------------------|
| M1714 | 1962-64 | Arm Rest Bases, Chrome |
| M1715 | 1965-67 | Arm Rest Bases, Chrome |

**MSRP \$50.00 pr**

## Window Seals

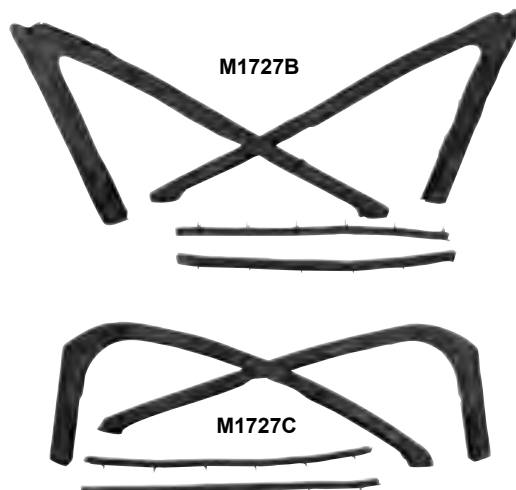

|        |         |                           |            |
|--------|---------|---------------------------|------------|
| M1727B | 1961-62 | Vent Window Seals, 4 pcs. | For 2 Door |
| M1727C | 1963-64 | Vent Window Seals, 4 pcs. | For 2 Door |

**MSRP \$74.00 set**

## Window Stoppers



|        |         |                                                |
|--------|---------|------------------------------------------------|
| M1727A | 1961-64 | Quarter Window Stoppers<br>2 door, Convertible |
| M1727D | 1961-62 | Vent Window Stoppers, Convertible              |
| M1727E | 1963-64 | Vent Window Stoppers, Hard Top                 |
| M1727F | 1963-64 | Vent Window Stoppers, Convertible              |

**MSRP \$22.00 pr**

**MSRP \$27.00 pr**

## Emblems

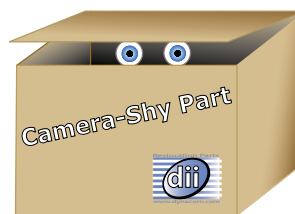

|        |     |      |                             |
|--------|-----|------|-----------------------------|
| EM1700 | New | 1962 | Quarter Panel Emblems       |
| EM1701 | New | 1962 | Quarter Panel Emblems, "SS" |

**Coming Soon!**

|        |     |      |                             |
|--------|-----|------|-----------------------------|
| EM1702 | New | 1963 | Quarter Panel Emblems       |
| EM1703 | New | 1963 | Quarter Panel Emblems, "SS" |

**Coming Soon!**

|        |     |      |                             |
|--------|-----|------|-----------------------------|
| EM1704 | New | 1964 | Quarter Panel Emblems       |
| EM1705 | New | 1964 | Quarter Panel Emblems, "SS" |

**Coming Soon!**

## U-Jamb Seals



|       |         |                            |
|-------|---------|----------------------------|
| M1727 | 1961-64 | U-Jamb Rubber Seals, Coupe |
|-------|---------|----------------------------|

**MSRP \$22.00 pr**

**Wholesale Only. MSRP not including Taxes, Shipping and Handling. MSRP are subject to change without notice**

Wholesale Only. MSRP not including Taxes, Shipping and Handling. MSRP are subject to change without notice

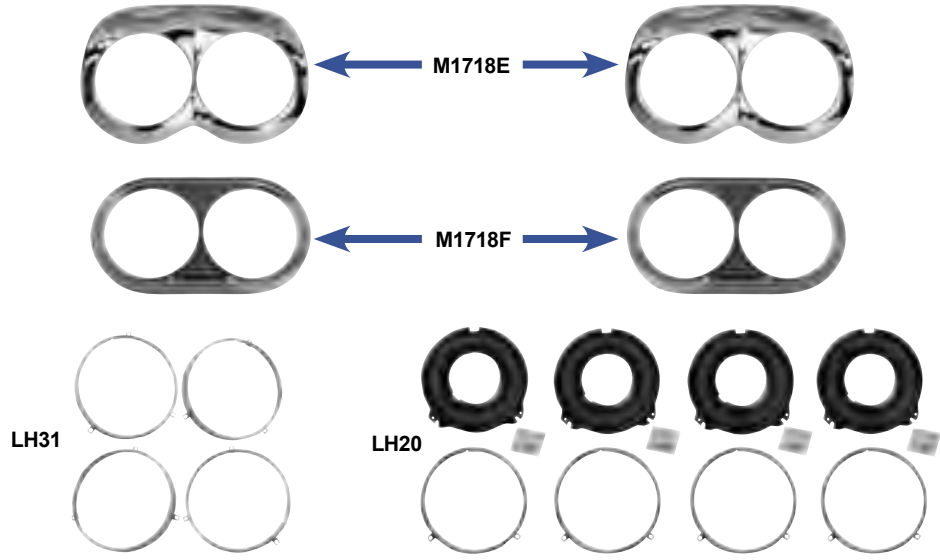

|        |         |                                      |                   |
|--------|---------|--------------------------------------|-------------------|
| M1718E | 1958    | Headlamp Bezels                      | MSRP \$135.00 pr  |
| M1718F | 1959    | Headlamp Bezels                      | MSRP \$135.00 pr  |
| LH20   | 1958-66 | Headlamp Mounting Bucket Set, 8 pcs. | MSRP \$127.00 set |
| LH31   | 1958-66 | Headlamp Retaining Rings, 4 pcs.     | MSRP \$24.00 set  |

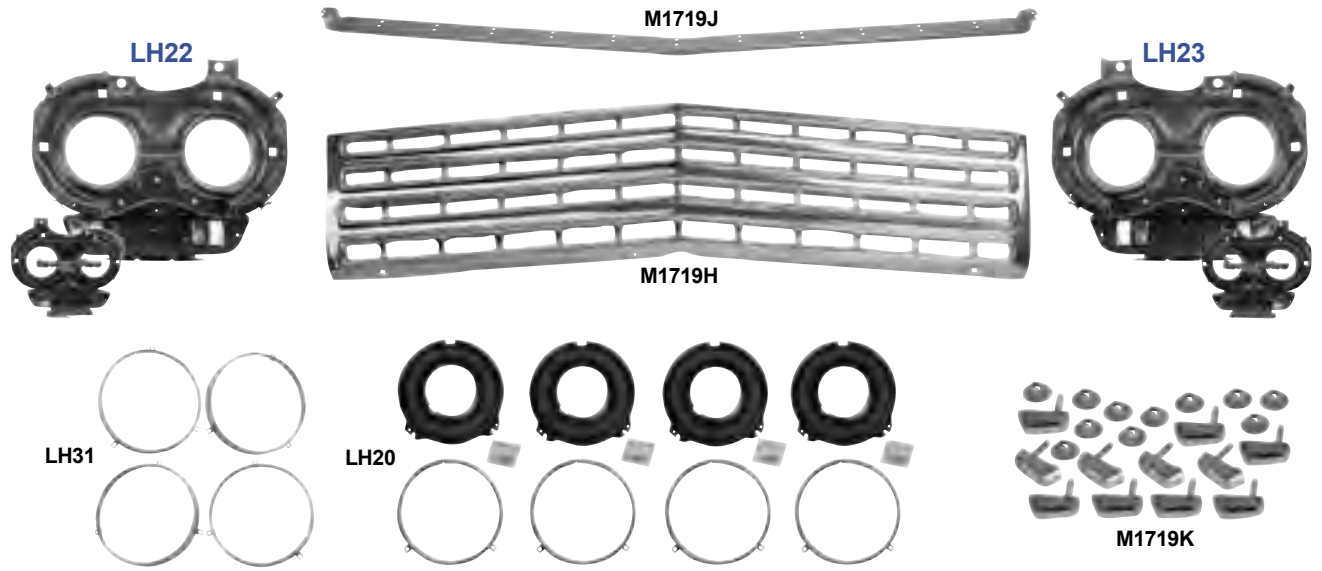

|         |     |         |                                       |                   |
|---------|-----|---------|---------------------------------------|-------------------|
| M1719H  |     | 1962    | Grille                                | MSRP \$404.00 ea  |
| M1719HC | New | 1962    | Complete Grille                       | Coming Soon!      |
| M1719J  |     | 1962    | Top Grille Molding                    | MSRP \$74.00 ea   |
| M1719K  |     | 1962    | Top Grille Molding Fasteners, 11 pcs. | MSRP \$34.00 kit  |
| LH20    |     | 1958-66 | Headlamp Mounting Bucket Set, 8 pcs.  | MSRP \$127.00 set |
| LH31    |     | 1958-66 | Headlamp Retaining Rings, 4 pcs.      | MSRP \$24.00 set  |
| M1719M  | New | 1962    | Headlamp Bezel, RH                    | Coming Soon!      |
| M1719N  | New | 1962    | Headlamp Bezel, LH                    | Coming Soon!      |
| LH22    |     | 1962    | Headlamp Bucket, RH                   | MSRP \$170.00 ea  |
| LH23    |     | 1962    | Headlamp Bucket, LH                   | MSRP \$170.00 ea  |

M1719F

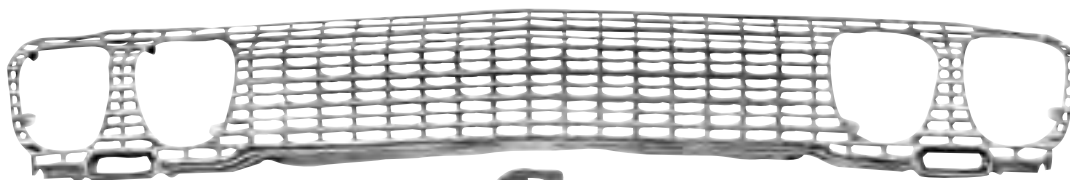

M1719FC

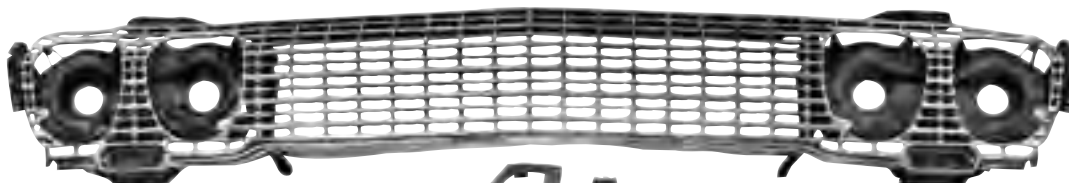

M1718B



M1724A



M1724A



LH31



LH20



|         |         |                                              |                          |
|---------|---------|----------------------------------------------|--------------------------|
| M1719F  | 1963    | Grille                                       | <b>MSRP \$535.00 set</b> |
| M1719FC | 1963    | Complete Grille W/Brackets,Headlamp Housings | <b>MSRP \$662.00 set</b> |
| M1718B  | 1963    | Headlamp Bezels, 4 pcs./set                  | <b>MSRP \$152.00 set</b> |
| M1724A  | 1963    | Upper Eyebrow Moldings                       | <b>MSRP \$69.00 pr</b>   |
| LH20    | 1958-66 | Headlamp Mounting Bucket Set, 8 pcs.         | <b>MSRP \$127.00 set</b> |
| LH3 1   | 1958-66 | Headlamp Retaining Rings, 4 pcs.             | <b>MSRP \$24.00 set</b>  |

Wholesale Only. MSRP not including Taxes, Shipping and Handling. MSRP are subject to change without notice

Wholesale Only. MSRP not including Taxes, Shipping and Handling. MSRP are subject to change without notice.

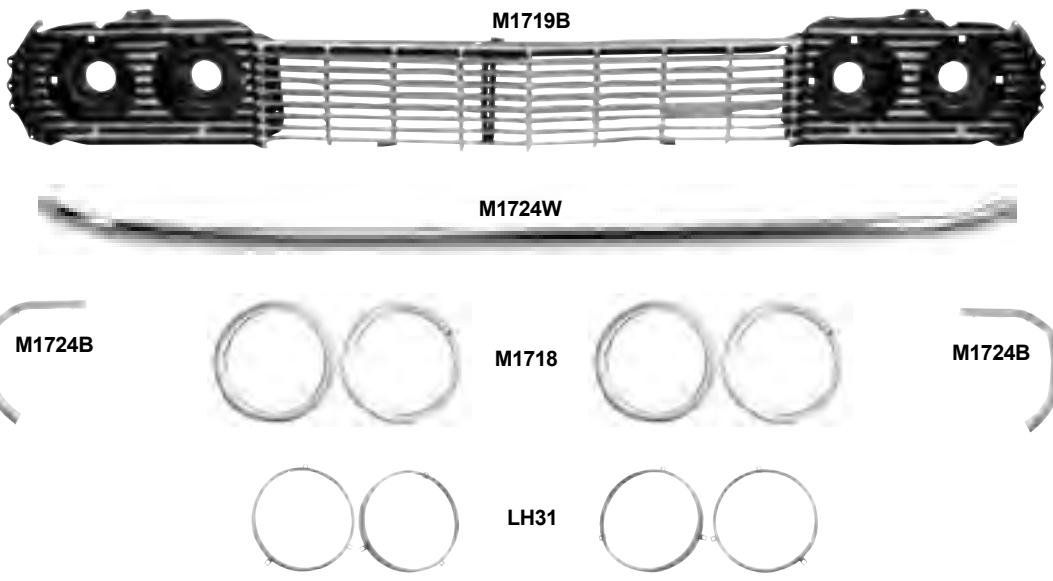

|        |         |                                       |                          |
|--------|---------|---------------------------------------|--------------------------|
| M1719B | 1964    | Grille W/Brackets & Headlamp Housings | <b>MSRP \$535.00 set</b> |
| M1724W | 1964    | Lower Grille Molding                  | <b>MSRP \$75.00 ea</b>   |
| M1718  | 1964    | Headlamp Bezels, 4 pcs./set           | <b>MSRP \$75.00 set</b>  |
| M1724B | 1964    | Eyebrow Moldings                      | <b>MSRP \$114.00 pr</b>  |
| LH20   | 1958-66 | Headlamp Mounting Bucket Set, 8 pcs.  | <b>MSRP \$127.00 set</b> |
| LH31   | 1958-66 | Headlamp Retaining Rings, 4 pcs.      | <b>MSRP \$24.00 set</b>  |

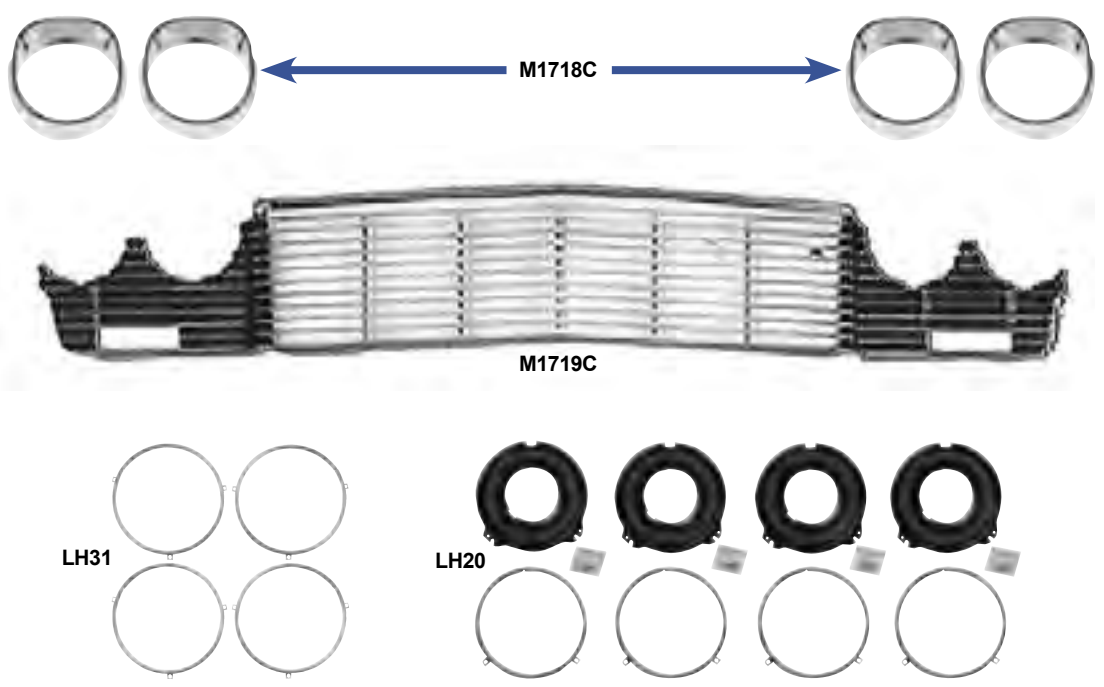

|        |         |                                      |                          |
|--------|---------|--------------------------------------|--------------------------|
| M1719C | 1965    | Grille                               | <b>MSRP \$592.00 ea</b>  |
| M1718C | 1965    | Headlamp Bezels, 4 pcs./set          | <b>MSRP \$187.00 set</b> |
| LH20   | 1958-66 | Headlamp Mounting Bucket Set, 8 pcs. | <b>MSRP \$127.00 set</b> |
| LH31   | 1958-66 | Headlamp Retaining Rings, 4 pcs.     | <b>MSRP \$24.00 set</b>  |

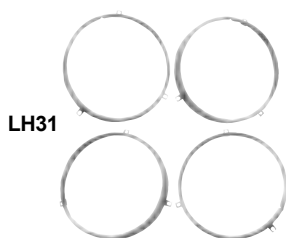
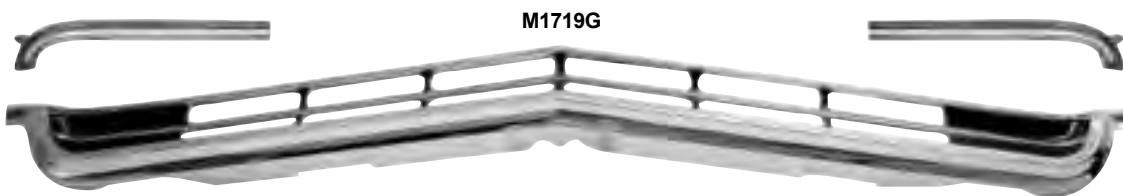

|        |         |                                      |                          |
|--------|---------|--------------------------------------|--------------------------|
| M1719G | 1966    | Lower Grille, 3 pcs.                 | <b>MSRP \$244.00 set</b> |
| M1724H | 1966    | Headlamp Bezels                      | <b>MSRP \$149.00 pr</b>  |
| M1724C | 1966    | Eyebrow Moldings                     | <b>MSRP \$59.00 pr</b>   |
| LH20   | 1958-66 | Headlamp Mounting Bucket Set, 8 pcs. | <b>MSRP \$127.00 set</b> |
| LH31   | 1958-66 | Headlamp Retaining Rings, 4 pcs.     | <b>MSRP \$24.00 set</b>  |



|        |      |                 |                         |
|--------|------|-----------------|-------------------------|
| M1718D | 1967 | Headlamp Bezels | <b>MSRP \$184.00 pr</b> |
|--------|------|-----------------|-------------------------|



|        |      |              |                         |
|--------|------|--------------|-------------------------|
| M1719D | 1968 | Upper Grille | <b>MSRP \$497.00 ea</b> |
| M1719E | 1968 | Lower Grille | <b>MSRP \$497.00 ea</b> |





Wholesale Only. MSRP not including Taxes, Shipping and Handling. MSRP are subject to change without notice.

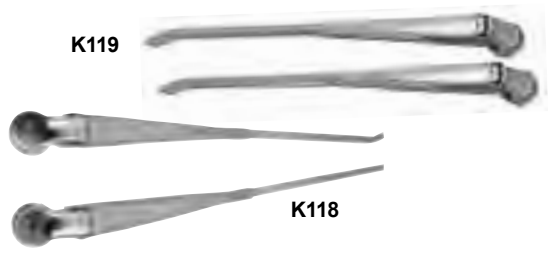

**Wiper Arms**

|      |         |            |                 |
|------|---------|------------|-----------------|
| K119 | 1963-64 | Wiper Arms | MSRP \$67.00 pr |
| K118 | 1966-67 | Wiper Arms | MSRP \$67.00 pr |

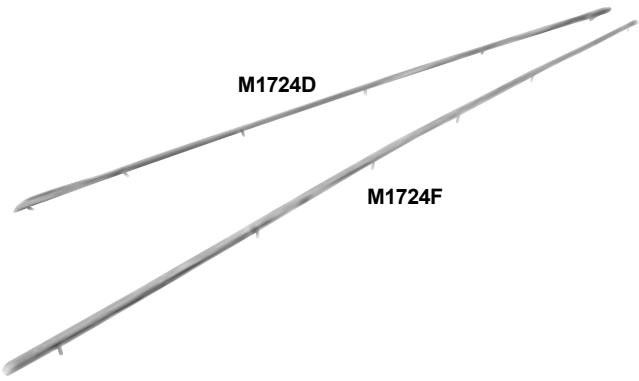

**Hood Spears**

|        |      |            |                  |
|--------|------|------------|------------------|
| M1724D | 1964 | Hood Spear | MSRP \$155.00 ea |
| M1724E | 1965 | Hood Spear | MSRP \$264.00 ea |
| M1724F | 1966 | Hood Spear | MSRP \$264.00 ea |



**Hood Moldings**

|        |      |              |                  |
|--------|------|--------------|------------------|
| M1725A | 1962 | Hood Molding | MSRP \$220.00 ea |
|--------|------|--------------|------------------|



**Hood Moldings**

|        |      |              |                  |
|--------|------|--------------|------------------|
| M1725B | 1963 | Hood Molding | MSRP \$267.00 ea |
|--------|------|--------------|------------------|



**Hood Moldings**

|        |      |              |                  |
|--------|------|--------------|------------------|
| M1725C | 1964 | Hood Molding | MSRP \$344.00 ea |
|--------|------|--------------|------------------|



**Wheel Opening Moldings**

|       |      |                                  |                   |
|-------|------|----------------------------------|-------------------|
| M1729 | 1965 | Wheel Opening Molding Set, 4 pcs | MSRP \$190.00 set |
| M1730 | 1966 | Wheel Opening Molding Set, 4 pcs | MSRP \$190.00 set |



**Wheel Opening Moldings**

|        |      |                                  |                   |
|--------|------|----------------------------------|-------------------|
| M1731  | 1967 | Wheel Opening Molding Set, 4 pcs | MSRP \$190.00 set |
| M1732  | 1968 | Wheel Opening Molding Set, 4 pcs | MSRP \$190.00 set |
| M1733A | New  | Wheel Opening Molding Set, 4 pcs | MSRP \$190.00 set |
| M1733  | 1970 | Wheel Opening Molding Set, 4 pcs | MSRP \$190.00 set |

Hood Moldings

Wheel Opening Moldings

## Wheel Opening Moldings, cont'd

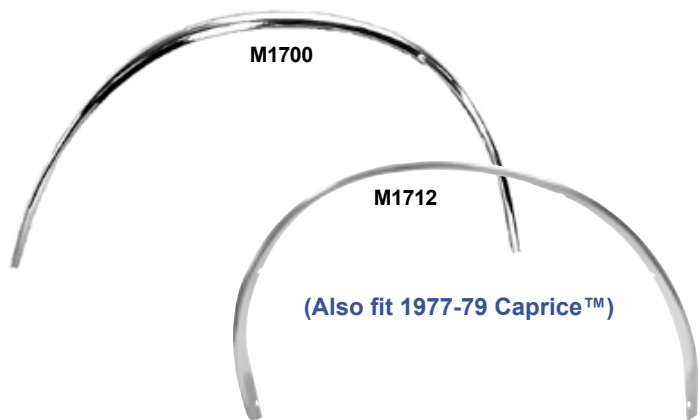

|       |         |                                 |
|-------|---------|---------------------------------|
| M1700 | 1977-79 | Front Wheel Opening Molding, RH |
| M1701 | 1977-79 | Front Wheel Opening Molding, LH |

**MSRP \$34.00 ea**

|       |         |                                |
|-------|---------|--------------------------------|
| M1702 | 1977-79 | Rear Wheel Opening Molding, RH |
| M1703 | 1977-79 | Rear Wheel Opening Molding, LH |

**MSRP \$34.00 ea**

|       |         |                                 |
|-------|---------|---------------------------------|
| M1710 | 1980-90 | Front Wheel Opening Molding, RH |
| M1711 | 1980-90 | Front Wheel Opening Molding, LH |

**MSRP \$29.00 ea**

|       |         |                                |
|-------|---------|--------------------------------|
| M1712 | 1980-90 | Rear Wheel Opening Molding, RH |
| M1713 | 1980-90 | Rear Wheel Opening Molding, LH |

**MSRP \$29.00 ea**

## Front Fender Molding

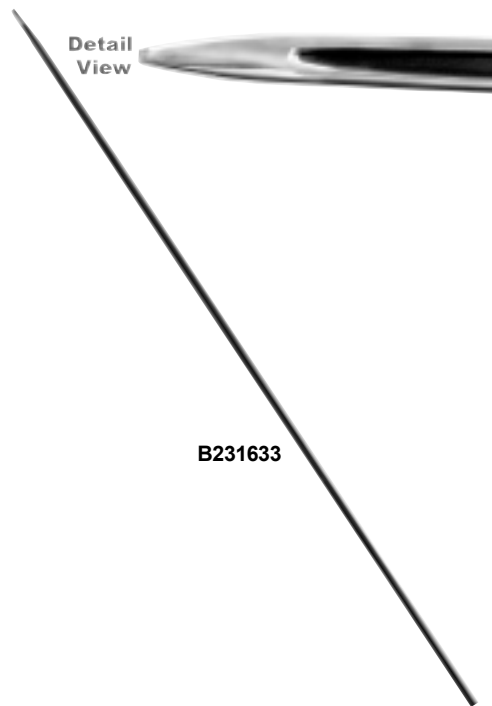

|       |      |                          |
|-------|------|--------------------------|
| M1706 | 1963 | Fender Molding, 4 pieces |
|-------|------|--------------------------|

**MSRP \$152.00 ea**

|         |      |                             |
|---------|------|-----------------------------|
| B231633 | 1966 | Front Fender Molding, RH/LH |
|---------|------|-----------------------------|

**MSRP \$69.00 ea**

## Windshield Moldings

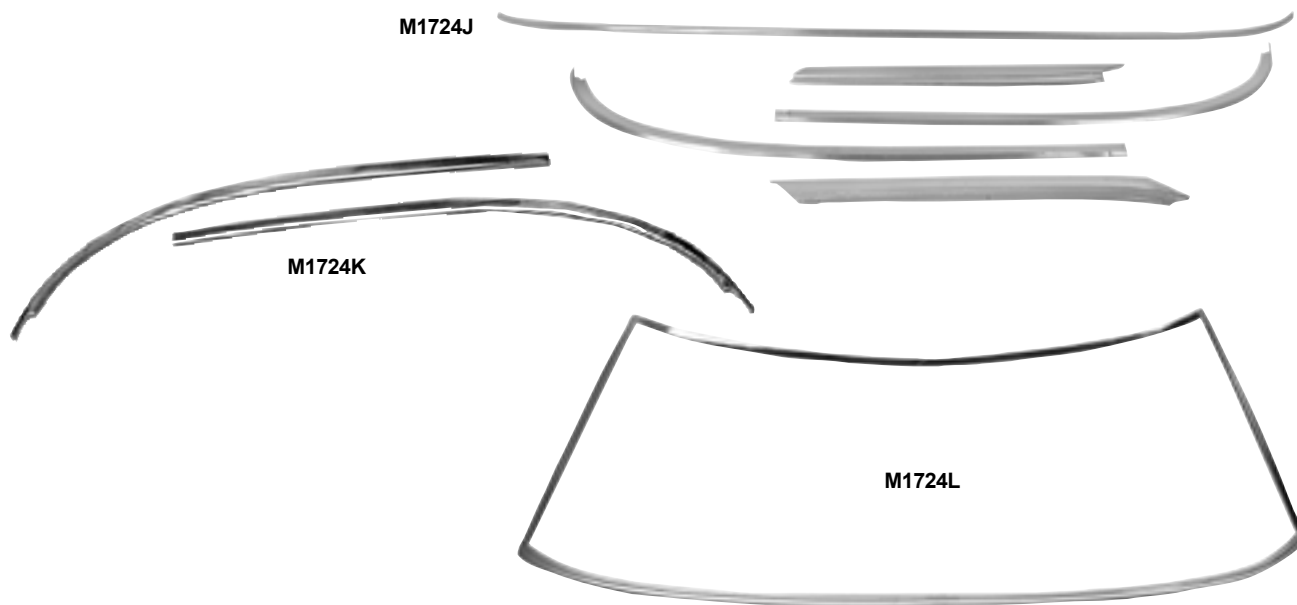

|        |         |                                |          |
|--------|---------|--------------------------------|----------|
| M1724K | 1962-64 | Windshield Moldings, 2 pc. set | Biscayne |
| M1724J | 1963-64 | Windshield Moldings, 5 pc. set |          |
| M1724L | 1965-67 | Windshield Moldings, 5 pc. set |          |

**MSRP \$80.00 set**

**MSRP \$220.00 set**

**MSRP \$205.00 set**

Wholesale Only. MSRP not including Taxes, Shipping and Handling. MSRP are subject to change without notice

Wholesale Only. MSRP not including Taxes, Shipping and Handling. MSRP are subject to change without notice



|         |         |                               |                         |
|---------|---------|-------------------------------|-------------------------|
| M1036A  | 1959-60 | Exterior Mirror               | <b>MSRP \$54.00 ea</b>  |
| M1036B  | 1961-62 | Exterior Mirror               | <b>MSRP \$54.00 ea</b>  |
| M1035   | 1963-64 | Exterior Mirror with "bowtie" | <b>MSRP \$30.00 ea</b>  |
| M1036C  | 1965-66 | Exterior Mirror, RH           | <b>MSRP \$59.00 ea</b>  |
| M1036D  | 1965-66 | Exterior Mirror, LH           | <b>MSRP \$59.00 ea</b>  |
| 3921816 | 1968    | Remote Mirror, LH             | <b>MSRP \$150.00 ea</b> |



|       |         |                 |                        |
|-------|---------|-----------------|------------------------|
| M1734 | 1961-64 | Scuff Plate, RH | <b>MSRP \$32.00 ea</b> |
| M1735 | 1961-64 | Scuff Plate, LH |                        |
| M1736 | 1965-70 | Scuff Plate, RH | <b>MSRP \$32.00 ea</b> |
| M1737 | 1965-70 | Scuff Plate, LH |                        |

## Exterior Mirrors

## Scuff Plates

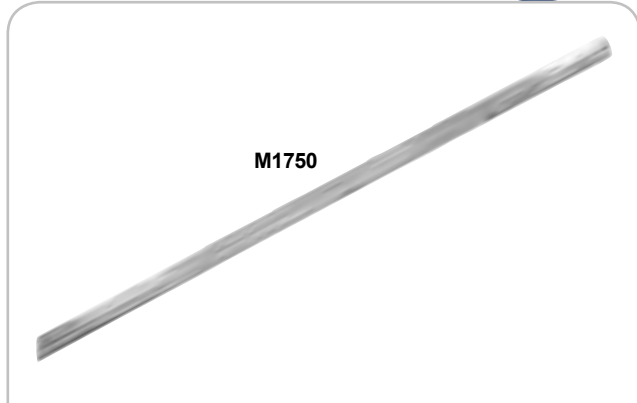

|       |         |                               |          |                        |
|-------|---------|-------------------------------|----------|------------------------|
| M1750 | 1961-64 | Rocker Panel Mldg w/clips, RH | Standard | <b>MSRP \$75.00 ea</b> |
| M1751 | 1961-64 | Rocker Panel Mldg w/clips, LH | Standard | <b>MSRP \$75.00 ea</b> |



|        |         |                                    |  |                         |
|--------|---------|------------------------------------|--|-------------------------|
| M1751C | 1962-64 | Rocker Panel Mldg Clips, 6 pcs/set |  | <b>MSRP \$22.00 set</b> |
|--------|---------|------------------------------------|--|-------------------------|

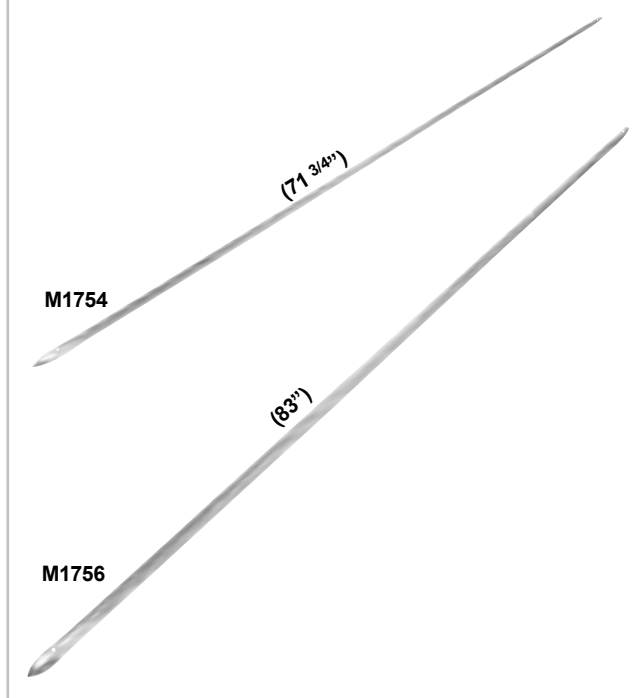

|       |         |                                |                         |
|-------|---------|--------------------------------|-------------------------|
| M1754 | 1965-66 | Rocker Panel Molding, For "SS" | <b>MSRP \$107.00 pr</b> |
| M1756 | 1968-69 | Rocker Panel Molding, For "SS" | <b>MSRP \$107.00 pr</b> |

## Rocker Panel Moldings

## Quarter Panel Molding

B222000



B223500



B222500 1961 Upper Quarter Panel Molding, RH 2 Door

**MSRP \$52.00 ea**

B222000 1961 Upper Quarter Panel Molding, LH 2 Door

**MSRP \$52.00 ea**

B223500 1961 Lower Quarter Panel Molding, RH 2 Door

**MSRP \$69.00 ea**

B223000 1961 Lower Quarter Panel Molding, LH 2 Door

**MSRP \$69.00 ea**

B223513



B223600

B223511 1961 Upper Quarter Panel Molding, RH 4 Door

**MSRP \$47.00 ea**

B223510 1961 Upper Quarter Panel Molding, LH 4 Door

**MSRP \$47.00 ea**

B223513 1961 Lower Quarter Panel Molding, RH 4 Door

**MSRP \$65.00 ea**

B223512 1961 Lower Quarter Panel Molding, LH 4 Door

**MSRP \$65.00 ea**

B223600 1961 Rear Wrap-Around Moldings

**MSRP \$72.00 pr**

B229500 1964 Upper Quarter Panel Molding, RH/LH 2 Door

**MSRP \$62.00 ea**

B229590 1964 Upper Qtr Panel Molding, RH/LH 4 Door

**MSRP \$67.00 ea**

B231640



B231650



B231640 1966 Rear Quarter Panel Molding, RH/LH 2 Door

**MSRP \$69.00 ea**

B231650 1966 Rear Wrap-Around Moldings, RH/LH

**MSRP \$69.00 pr**

## Rear Windshield Molding



M1724N 1962-64 Rear Window Moldings, 5 pieces

**MSRP \$220.00 set**



M1724M 1965-66 Rear Window Moldings, 5 pieces

**MSRP \$202.00 set**

## Trunk Spear



M1724G 1964 Trunk Spear with clips

**MSRP \$105.00 ea**

Wholesale Only. MSRP not including Taxes, Shipping and Handling. MSRP are subject to change without notice



Wholesale Only. MSRP not including Taxes, Shipping and Handling. MSRP are subject to change without notice

Drip Rail Mldg.



|       |         |                    |                  |
|-------|---------|--------------------|------------------|
| M1738 | 1962-64 | Drip Rail Moldings | MSRP \$140.00 pr |
|-------|---------|--------------------|------------------|

Trunk Molding



|         |      |                             |                  |
|---------|------|-----------------------------|------------------|
| B223650 | 1961 | Trunk Moldings              | MSRP \$114.00 pr |
| B223900 | 1962 | Upper Trunk Molding         | MSRP \$69.00 ea  |
| B223950 | 1962 | Tail Lamp Cove Moldings     | MSRP \$84.00 pr  |
| B226000 | 1963 | Lower Trunk Molding w/clips | MSRP \$75.00 ea  |



|         |      |                                |                 |
|---------|------|--------------------------------|-----------------|
| B230000 | 1964 | Upper Trunk Molding, Belair/SS | MSRP \$75.00 ea |
| B231000 | 1964 | Lower Trunk Molding, Belair/SS | MSRP \$75.00 ea |
| B230500 | 1964 | Outer Cove Moldings, Belair/SS | MSRP \$75.00 pr |
| B231500 | 1964 | Inner Cove Moldings, Belair/SS | MSRP \$75.00 pr |

Trunk Lid Molding

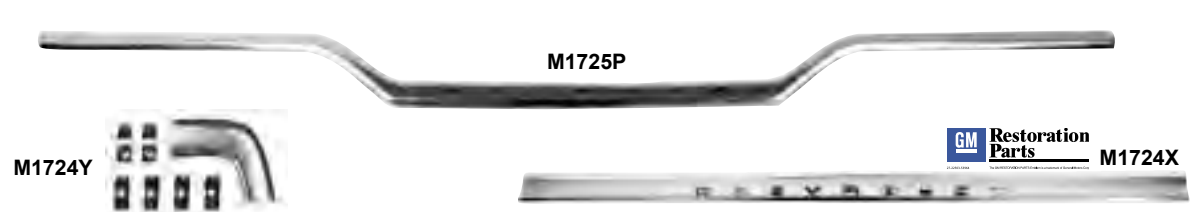

|         |      |                                       |                  |
|---------|------|---------------------------------------|------------------|
| M1725P  | 1963 | Upper Trunk Lid Molding               | MSRP \$229.00 ea |
| M1724X  | 1964 | Standard Rear Panel Molding w/clips   | MSRP \$132.00 ea |
| M1724Y  | 1964 | Quarter Extension Molding w/clips, RH | MSRP \$39.00 ea  |
| M1724Z  | 1964 | Quarter Extension Molding w/clips, LH | MSRP \$39.00 ea  |
| B231660 | 1966 | Trunk Lid Molding                     | MSRP \$145.00 ea |

## License Panels

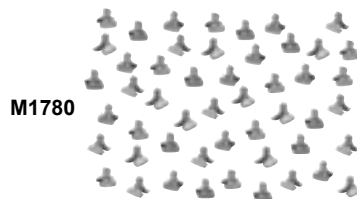

|         |         |                                 |                         |
|---------|---------|---------------------------------|-------------------------|
| B244500 | 1962    | Front License Panel             | <b>MSRP \$94.00 ea</b>  |
| B245000 | 1962    | Rear License Panel              | <b>MSRP \$94.00 ea</b>  |
| B245500 | 1963    | Front License Panel             | <b>MSRP \$80.00 ea</b>  |
| B246000 | 1963    | Rear License Panel              | <b>MSRP \$80.00 ea</b>  |
| B246500 | 1964    | Front License Panel             | <b>MSRP \$87.00 ea</b>  |
| B247000 | 1964    | Rear License Panel              | <b>MSRP \$87.00 ea</b>  |
| M1780   | 1962-64 | License Panel Clips, 50 pc. set | <b>MSRP \$39.00 set</b> |

## License Frames



LF64 thru LF72 1964-72 License Plate Frame  
**MSRP \$15.00 ea**

## Shifter Lever



1498G New 1964-67 Shifter Lever w/Push Button, Automatic  
**MSRP \$132.00 ea**

## Parking Brake Assemblies

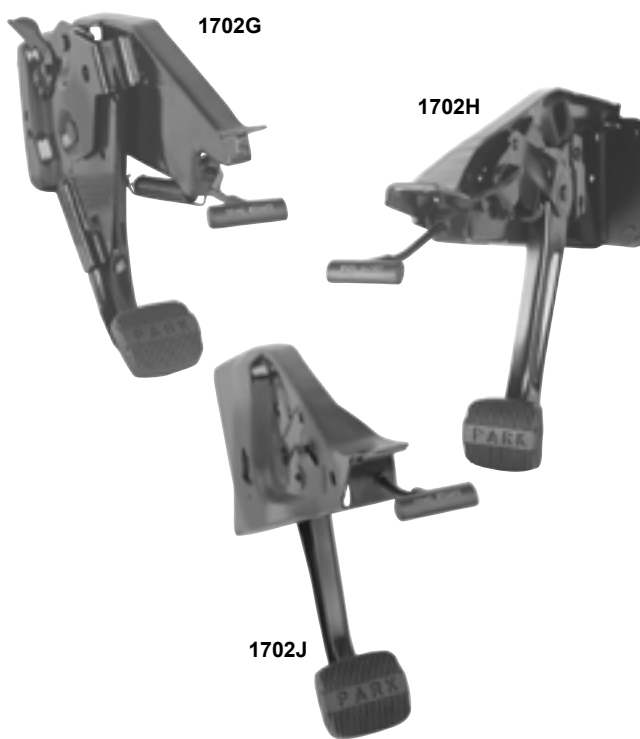

|       |          |                                  |                         |
|-------|----------|----------------------------------|-------------------------|
| 1702G | 1963     | Parking Brake Assembly           | <b>MSRP \$112.00 ea</b> |
| 1702M | New 1963 | Parking Brake Cable Guide Pulley | <b>Coming Soon!</b>     |
| 1702H | 1964     | Parking Brake Assembly           | <b>MSRP \$112.00 ea</b> |
| 1702J | 1965     | Parking Brake Assembly           | <b>MSRP \$112.00 ea</b> |

Wholesale Only. MSRP not including Taxes, Shipping and Handling. MSRP are subject to change without notice

Wholesale Only. MSRP not including Taxes, Shipping and Handling. MSRP are subject to change without notice



M1339 1963-70 Parking Brake Release Handle  
**MSRP \$10.00 ea**



M1726E 1965-70 Parking Brake Pedal Pad  
**MSRP \$7.00 ea**  
 M1726F 1965-70 Parking Brake Pedal Pad Trim  
**MSRP \$7.00 ea**

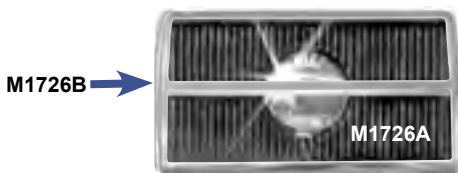

M1726A 1965-70 Disc Brake Pedal Pad, Auto. Transmission  
**MSRP \$14.00 ea**  
 M1726B 1965-70 Disc Brake Pedal Pad Trim  
**MSRP \$10.00 ea**  
 M1726C 1965-70 Brake Pedal Pad, Manual Transmission  
**MSRP \$10.00 ea**  
 M1726D 1965-70 Brake Pedal Pad Trim Manual Transmission  
**MSRP \$10.00 ea**

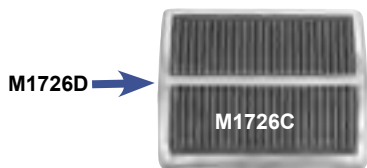

P. Brake Release Handle

Brake Pedal Pads & Trim

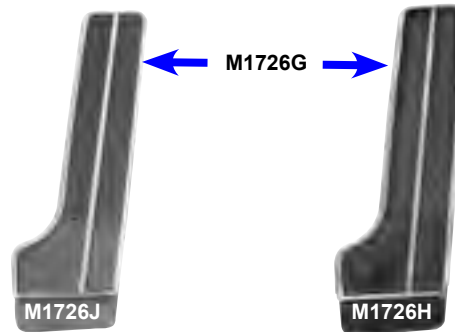

M1726J 1958-63 Accelerator Pedal Pad  
**MSRP \$19.00 ea**

M1726G 1965 Accelerator Pedal Pad  
**MSRP \$14.00 ea**

M1726H 1965 Accelerator Pedal Pad Trim  
**MSRP \$12.00 ea**

Accelerator Pedal Pad & Trim

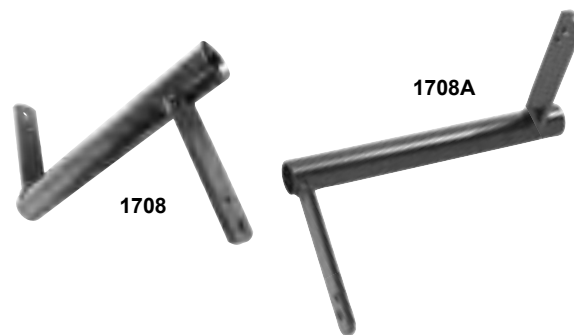

1708 1962-64 Clutch Countershaft (Z-bar)  
**MSRP \$30.00 ea**

1708A 1965-70 Clutch Countershaft (Z-bar)  
**MSRP \$37.00 ea**

Clutch Countershaft (Z-Bar)



1794 New 1963-64 Glovebox Door  
**MSRP \$152.00 ea**

1794A New 1963-64 Glovebox Door Hinge  
**Coming Soon!**

Glovebox Door

## Steering Wheels



769868

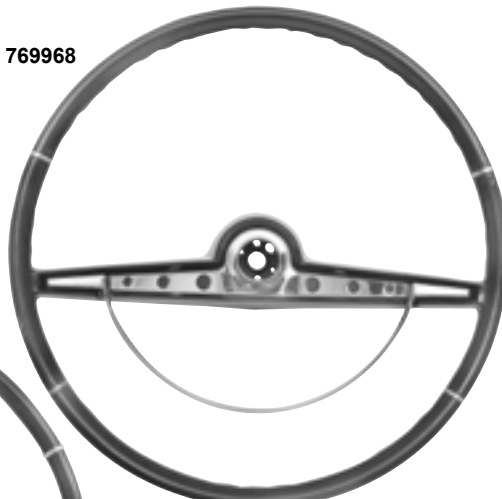

769968



9740631

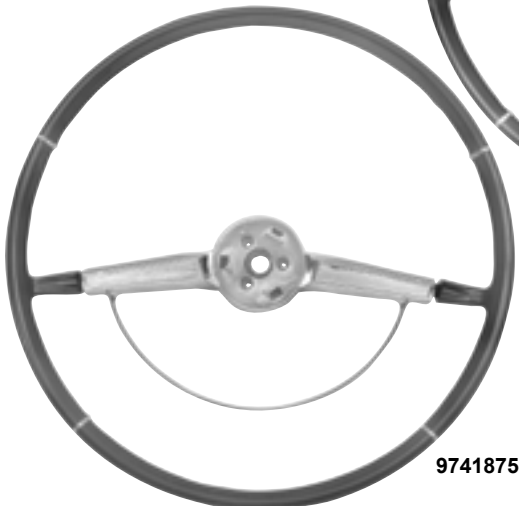

9741875



3939731

|         |         |                       |                         |
|---------|---------|-----------------------|-------------------------|
| 769868  | 1962    | Steering Wheel, Black | <b>MSRP \$359.00 ea</b> |
| 769968  | 1963    | Steering Wheel, Black | <b>MSRP \$359.00 ea</b> |
| 9740631 | 1964    | Steering Wheel, Black | <b>MSRP \$359.00 ea</b> |
| 9741875 | 1965-66 | Steering Wheel, Black | <b>MSRP \$359.00 ea</b> |
| 3939731 | 1969-70 | Steering Wheel, Black | <b>MSRP \$264.00 ea</b> |

## Horn Caps



3841275



3874620



3858429

|         |      |          |                        |
|---------|------|----------|------------------------|
| 3841275 | 1964 | Horn Cap | <b>MSRP \$65.00 ea</b> |
| 3858429 | 1965 | Horn Cap |                        |
| 3874620 | 1966 | Horn Cap |                        |

## Decal



|      |                        |                       |
|------|------------------------|-----------------------|
| FL01 | "Body by Fisher" Decal | <b>MSRP \$2.00 ea</b> |
|------|------------------------|-----------------------|

Wholesale Only. MSRP not including Taxes, Shipping and Handling. MSRP are subject to change without notice



Wholesale Only. MSRP not including Taxes, Shipping and Handling. MSRP are subject to change without notice

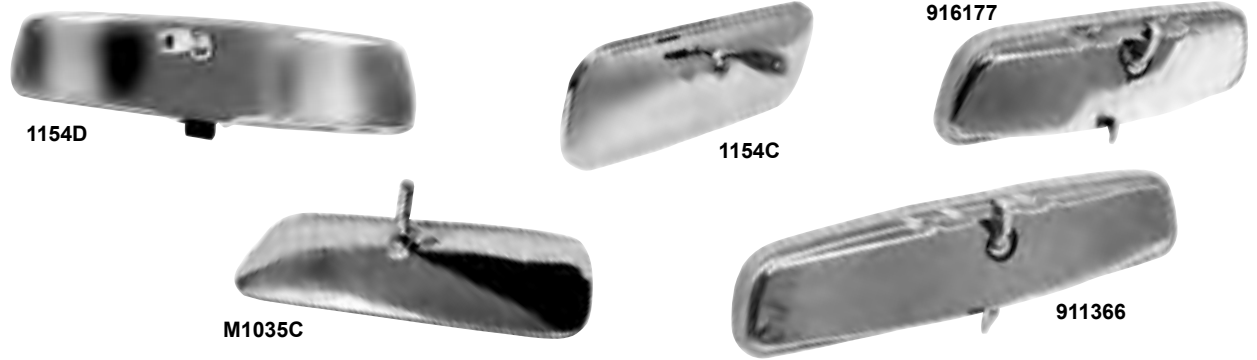

|        |         |                            |                        |
|--------|---------|----------------------------|------------------------|
| 1154D  | 1957-62 | Interior Mirror, Day/Night | <b>MSRP \$67.00 ea</b> |
| 1154C  | 1958-62 | Interior Mirror, Stainless | <b>MSRP \$24.00 ea</b> |
| 916177 | 1963-64 | Interior Mirror, 8 inch    | <b>MSRP \$49.00 ea</b> |
| M1035C | 1963-66 | Interior Mirror, Standard  | <b>MSRP \$27.00 ea</b> |
| 911366 | 1965-72 | Interior Mirror, 10 inch   | <b>MSRP \$47.00 ea</b> |

**Interior Mirrors**



|       |         |                             |                        |
|-------|---------|-----------------------------|------------------------|
| M1781 | 1959-63 | Sun Visor Brackets w/screws | <b>MSRP \$57.00 ea</b> |
| M1338 | 1964-68 | Sun Visor Bracket           | <b>MSRP \$20.00 ea</b> |

**Visor Brackets**



1709A (top)

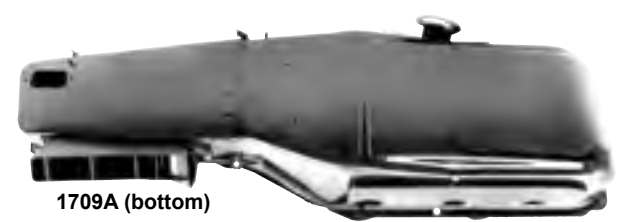

1709A (bottom)

|       |             |                       |                         |
|-------|-------------|-----------------------|-------------------------|
| 1709A | 1963        | Heater Core Case      | <b>MSRP \$355.00 ea</b> |
| 1709B | New 1964    | Heater Core Case      | <b>Call For Price</b>   |
| 1709C | New 1963-64 | Heater Core Case Vent | <b>Call For Price</b>   |

**Heater Core Cases**



|      |         |                           |                        |
|------|---------|---------------------------|------------------------|
| 1709 | 1963-64 | Metal Heater Box Assembly | <b>MSRP \$45.00 ea</b> |
|------|---------|---------------------------|------------------------|

**Heater Box Assembly**

## Fresh Air Vent Assemblies

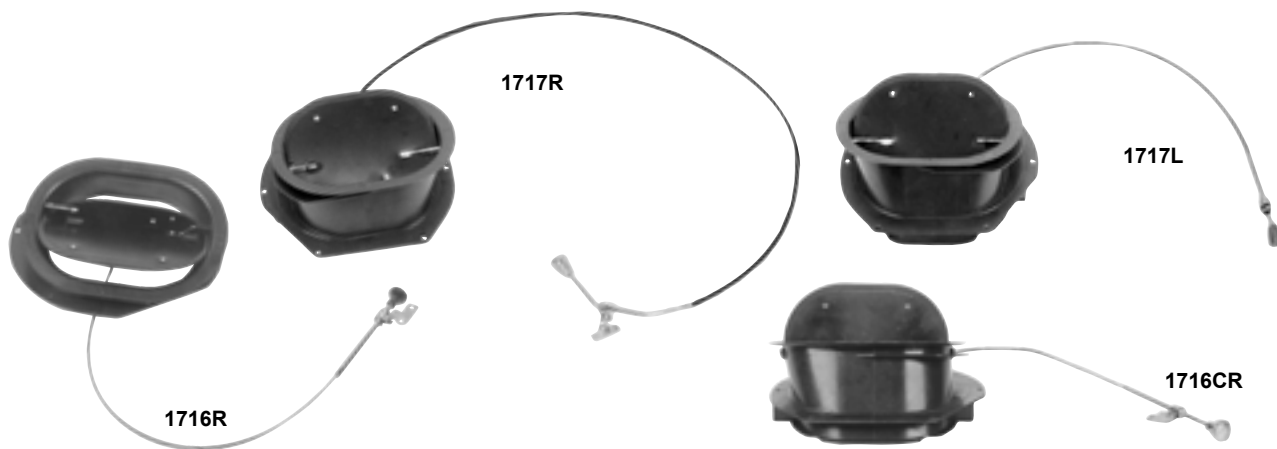

|        |      |                                                |                         |
|--------|------|------------------------------------------------|-------------------------|
| 1717R  | 1963 | Fresh Air Vent Assembly, RH Chrome Knob        | <b>MSRP \$107.00 ea</b> |
| 1717L  | 1963 | Fresh Air Vent Assembly, LH Chrome Knob        | <b>MSRP \$107.00 ea</b> |
| 1716R  | 1964 | Fresh Air Vent Assembly, RH Std Knob           | <b>MSRP \$107.00 ea</b> |
| 1716L  | 1964 | Fresh Air Vent Assembly, LH Std Knob           | <b>MSRP \$107.00 ea</b> |
| 1716CR | 1964 | Fresh Air Vent Assembly, RH Deluxe Chrome Knob | <b>MSRP \$107.00 ea</b> |
| 1716CL | 1964 | Fresh Air Vent Assembly, LH Deluxe Chrome Knob | <b>MSRP \$107.00 ea</b> |

## A/C Vent Ball



3856472 1965-68 A/C Vent Ball  
(\*67 w/ A/C and all '68 Astro-Vent)

**MSRP \$27.00 ea**

## Parking Lamp

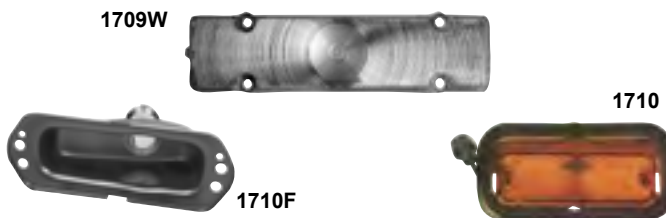

|       |      |                             |                        |
|-------|------|-----------------------------|------------------------|
| 1709W | 1961 | Parking Lamp Lens, Clear    | <b>MSRP \$10.00 ea</b> |
| 1710F | 1963 | Parking Lamp Housing, RH/LH | <b>MSRP \$34.00 ea</b> |
| 1710  | 1964 | Parking Lamp Assembly       | <b>MSRP \$47.00 ea</b> |

## Back Up Lenses & Trim

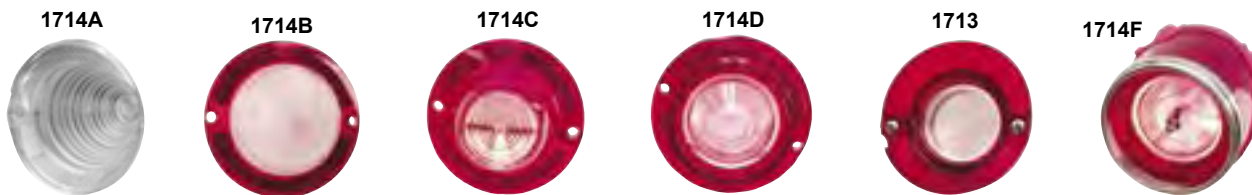

|       |      |                                   |                        |
|-------|------|-----------------------------------|------------------------|
| 1714A | 1960 | Back Up Lens, Clear               | <b>MSRP \$9.00 ea</b>  |
| 1714B | 1961 | Back Up Lens, White/Red           | <b>MSRP \$9.00 ea</b>  |
| 1714C | 1962 | Back Up Lens, White/Red           | <b>MSRP \$7.00 ea</b>  |
| 1714D | 1963 | Back Up Lens, White/Red           | <b>MSRP \$9.00 ea</b>  |
| 1713  | 1964 | Back Up Lens, White/Red with Trim | <b>MSRP \$24.00 ea</b> |
| 1714F | 1965 | Back Up Lens                      | <b>MSRP \$19.00 ea</b> |

Wholesale Only. MSRP not including Taxes, Shipping and Handling- MSRP are subject to change without notice

**Wholesale Only. MSRP not including Taxes, Shipping and Handling. MSRP are subject to change without notice.**

**Tail Lamp Components**



|       |          |                                           |                         |
|-------|----------|-------------------------------------------|-------------------------|
| 1710A | 1962     | Tail Lamp Lens, Red                       | <b>MSRP \$7.00 ea</b>   |
| 1710B | New 1962 | Tail Lamp Lens Trim                       | <b>Coming Soon!</b>     |
| 1734A | 1963     | Tail Lamp Housing, RH (3 per car)         | <b>MSRP \$40.00 ea</b>  |
| 1734B | 1963     | Tail Lamp Housing, LH (3 per car)         | <b>MSRP \$40.00 ea</b>  |
| 1711  | 1963     | Tail Lamp Lenses, 3 Pcs. With Chrome Trim | <b>MSRP \$54.00 set</b> |
| 1714E | 1963     | Tail Lamp Lens Trim                       | <b>MSRP \$9.00 ea</b>   |
| 1734C | 1964     | Tail Lamp Housing                         | <b>MSRP \$42.00 ea</b>  |
| 1712  | 1964     | Tail Lamp Lens, Red With Chrome Trim      | <b>MSRP \$19.00 ea</b>  |
| 1714  | 1965     | Tail Lamp Lens, Red With Chrome Trim      | <b>MSRP \$19.00 ea</b>  |

**Headlamp Switches**

|        |         |                        |                        |
|--------|---------|------------------------|------------------------|
| M1013A | 1955-56 | Headlamp Switch        | <b>MSRP \$42.00 ea</b> |
| LH01   | 1962-72 | Headlamp Dimmer Switch | <b>MSRP \$7.00 ea</b>  |
| M1013  | 1964-67 | Headlamp Switch        | <b>MSRP \$14.00 ea</b> |
| M1013B | 1969-84 | Headlamp Switch        | <b>MSRP \$19.00 ea</b> |

**Cig. Lighter**

|         |      |                   |                        |
|---------|------|-------------------|------------------------|
| 7031884 | 1967 | Cigarette Lighter | <b>MSRP \$27.00 ea</b> |
|---------|------|-------------------|------------------------|

**Dome Light**

|          |         |                 |                        |
|----------|---------|-----------------|------------------------|
| 8732777  | 1971-81 | Dome Light Lens | <b>MSRP \$7.00 ea</b>  |
| 20030351 | 1971-81 | Dome Light Base | <b>MSRP \$20.00 ea</b> |

**Wiper Switches**

|       |         |                                            |                        |
|-------|---------|--------------------------------------------|------------------------|
| 1702P | 1959-63 | Windshield Wiper Switch, 2 Speed W/ Washer | <b>MSRP \$50.00 ea</b> |
| 1702Q | 1965-66 | Windshield Wiper Switch, 2 Speed W/ Washer | <b>MSRP \$47.00 ea</b> |

## Horns

1010H



1010L



1010H 1962-72 Horn - High  
1010L 1962-72 Horn - Low

**MSRP \$75.00 ea**

## Body Bushing Kits

M1726K

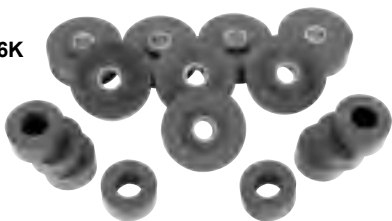

M1726K 1960-64 Body Bushings, 8 Large, 8 Small

**MSRP \$34.00 set**

M1728 1965-66 Body Bushings w/bolts, Hard Top

**MSRP \$132.00 set**

M1728A 1965-66 Body Bushings w/bolts, Convertible

**MSRP \$152.00 set**

M1728B 1967-68 Body Bushings w/bolts, Hard Top

**MSRP \$132.00 set**

M1728C 1967-68 Body Bushings w/bolts, Convertible

**MSRP \$152.00 set**

M1728D 1969-70 Body Bushings w/bolts, Hard Top

**MSRP \$132.00 set**

M1728E 1969-70 Body Bushings w/bolts, Convertible

**MSRP \$152.00 set**

## Tr. Arm Bushings

M1726L



M1726M



M1726L 1959-64 Trailing Arm Bushings, Upper Front & Rear / Lower Rear

1965-70 Trailing Arm Bushings, Lower Front  
(With Large Diameter Bushings)

M1726M 1959-64 Trailing Arm Bushings, Lower Front

**MSRP \$14.00 ea**

## Ctrl. Arm Bumper

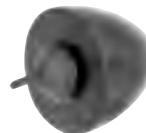

1007 1958-70 Control Arm Bumper

**MSRP \$5.00 ea**

## Ignition Locks

102



161 1958-64 Original **MSRP \$17.00 kit**

157 1958-64 Octagonal **MSRP \$14.00 kit**

158A 1965 Original **MSRP \$15.00 kit**

158 1965 Octagonal **MSRP \$12.00 kit**

100A 1966-67 Original **MSRP \$17.00 kit**

100 1966-67 Later **MSRP \$14.00 kit**

102 1969-78 Later **MSRP \$17.00 kit**

## Ignition & Door Locks

160A

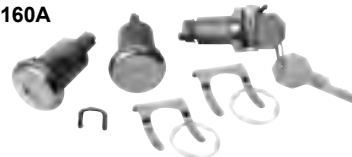

243 1958 Original w/flat pawl **MSRP \$57.00 kit**

160A 1958 Original w/long cyl. **MSRP \$54.00 kit**  
1961-64

457 1959-60 Orig. w/long cyl. & pawl **MSRP \$57.00 kit**

250 1961-64 Original w/flat pawl **MSRP \$57.00 kit**

143A 1965 Original **MSRP \$54.00 kit**

106

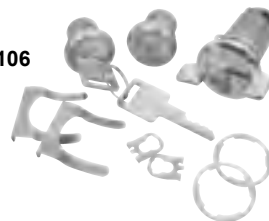

104A 1966-68 Octagonal **MSRP \$37.00 kit**

104 1966-72 Later **MSRP \$30.00 kit**

106 1969-78 Later **MSRP \$37.00 kit**

219 1971-76 Later **MSRP \$39.00 kit**

Wholesale Only. MSRP not including Taxes, Shipping and Handling. MSRP are subject to change without notice

**Wholesale Only. MSRP not including Taxes, Shipping and Handling. MSRP are subject to change without notice**



|     |         |                                   |                         |
|-----|---------|-----------------------------------|-------------------------|
| 422 | 1958    | Original w/ long cylinder         | <b>MSRP \$94.00 kit</b> |
| 423 | 1958    | Original w/ short cylinder        | <b>MSRP \$94.00 kit</b> |
| 424 | 1961-62 | Original w/ long cylinder         | <b>MSRP \$80.00 kit</b> |
| 425 | 1961-62 | Original w/ short cylinder & pawl | <b>MSRP \$85.00 kit</b> |
| 426 | 1963    | Original w/ long cylinder         | <b>MSRP \$90.00 kit</b> |
| 427 | 1963    | Original w/ short cylinder & pawl | <b>MSRP \$94.00 kit</b> |
| 428 | 1964    | Original w/ long cylinder         | <b>MSRP \$90.00 kit</b> |
| 429 | 1964    | Original w/ short cylinder & pawl | <b>MSRP \$94.00 kit</b> |
| 430 | 1965    | Original                          | <b>MSRP \$77.00 kit</b> |
| 431 | 1966    | Original                          | <b>MSRP \$77.00 kit</b> |
| 332 | 1967    | Original                          | <b>MSRP \$74.00 kit</b> |
| 334 | 1969-70 | Later                             | <b>MSRP \$75.00 kit</b> |
| 335 | 1971-76 | Later                             | <b>MSRP \$94.00 kit</b> |

## Ignition, Door, Glove & Trunk Kits

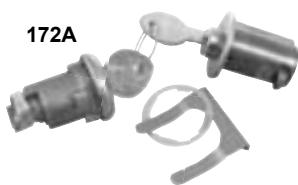

|      |                 |          |                         |
|------|-----------------|----------|-------------------------|
| 172A | 1958-60<br>1963 | Original | <b>MSRP \$42.00 kit</b> |
| 172  | 1958-60<br>1963 | Later    | <b>MSRP \$37.00 kit</b> |
| 460  | 1959            | Original | <b>MSRP \$55.00 kit</b> |
| 171A | 1961-62         | Original | <b>MSRP \$42.00 kit</b> |
| 171  | 1961-62         | Later    | <b>MSRP \$37.00 kit</b> |
| 121A | 1964            | Original | <b>MSRP \$42.00 kit</b> |
| 121  | 1964            | Later    | <b>MSRP \$37.00 kit</b> |
| 174A | 1965-66         | Original | <b>MSRP \$42.00 kit</b> |
| 174  | 1965            | Later    | <b>MSRP \$37.00 kit</b> |
| 175A | 1967            | Original | <b>MSRP \$42.00 kit</b> |
| 175  | 1967            | Later    | <b>MSRP \$37.00 kit</b> |
| 150A | 1968            | Original | <b>MSRP \$47.00 kit</b> |
| 150  | 1968-76         | Later    | <b>MSRP \$40.00 kit</b> |

## Glovebox & Trunk Lock Kits

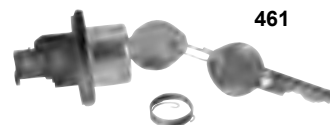

|       |         |                                 |                         |
|-------|---------|---------------------------------|-------------------------|
| 112AR | 1958    | Original w/ original ribbed cap | <b>MSRP \$25.00 kit</b> |
| 112   | 1958-94 | Later (excluding 1959)          | <b>MSRP \$17.00 kit</b> |
| 461   | 1959    | Original                        | <b>MSRP \$35.00 kit</b> |
| 112A  | 1960-68 | Original                        | <b>MSRP \$22.00 kit</b> |

## Trunk Locks

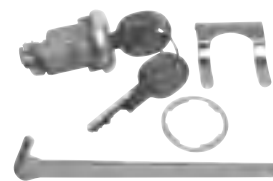

|      |         |                       |                         |
|------|---------|-----------------------|-------------------------|
| 1575 | 1953-94 | Later (Kit with pawl) | <b>MSRP \$14.00 kit</b> |
|------|---------|-----------------------|-------------------------|

## Trunk Lock Kit

*See also our Lock Section for more details...*



|      |                 |          |                         |
|------|-----------------|----------|-------------------------|
| 168A | 1958-60<br>1963 | Original | <b>MSRP \$29.00 kit</b> |
| 168  | 1958-60<br>1963 | Later    | <b>MSRP \$25.00 kit</b> |
| 169A | 1961-62         | Original | <b>MSRP \$34.00 kit</b> |
| 169  | 1961-62         | Later    | <b>MSRP \$25.00 kit</b> |
| 118A | 1964            | Original | <b>MSRP \$27.00 kit</b> |
| 118  | 1964            | Later    | <b>MSRP \$24.00 kit</b> |

## Glovebox Locks



|      |         |          |                         |
|------|---------|----------|-------------------------|
| 165A | 1965-66 | Original | <b>MSRP \$29.00 kit</b> |
| 165  | 1965-66 | Later    | <b>MSRP \$24.00 kit</b> |
| 166A | 1967    | Original | <b>MSRP \$29.00 kit</b> |
| 166  | 1967    | Later    | <b>MSRP \$24.00 kit</b> |
| 119A | 1968-76 | Original | <b>MSRP \$49.00 kit</b> |
| 119  | 1968-76 | Later    | <b>MSRP \$42.00 kit</b> |



# RetroSound

*Modern Sound for Your Classic*

## CLASSIC CAR RADIO & ACCESSORIES

### IMPALA



2010 RetroSound Catalog Version 1

ORDER LINE 1-866-640-1324

**2010**

FAX LINE 1-905-850-1722



**RetroSound**<sup>®</sup>  
Modern Sound for your Classic

<http://www.retrosoundcanada.com>

---

## INDEX

---

# Index

### RADIO SYSTEM

|                           |       |
|---------------------------|-------|
| CLASSIC SOUND:.....       | RSC-1 |
| MODEL ONE:.....           | RSC-2 |
| RADIO SPECIFICATION:..... | RSC-3 |
| FACEPLATE:.....           | RSC-4 |
| ACCESSORIES:              |       |
| KNOBS:.....               | RSC-5 |
| DASH HOLE CUPS:.....      | RSC-5 |
| REMOTE:.....              | RSC-5 |
| IR CABLE:.....            | RSC-5 |

### LOUDSPEAKERS

|                   |       |
|-------------------|-------|
| DESCRIPTION:..... | RSC-6 |
| DVC SPEAKER:..... | RSC-7 |
| SVC SPEAKER:..... | RSC-8 |



**RetroSound**<sup>®</sup>  
Modern Sound for your Classic

<http://www.retrosoundcanada.com>

## RADIO SYSTEM



Revolutionary patent - pending  
INFINIMOUNT system allows for  
infinite movement of bracket & shaft  
knobs to meet virtually any install need!

Front and Rear Aux-in analog inputs  
allow you to plug in any portable device  
(Mp3 player, satellite unit, Portable CD)  
The possibilities are endless!

## CS-900

### FEATURES:

- FRONT AUX INPUT, PLUG IN ANY MP3 PLAYER OR OTHER PORTABLE DEVICE, (CELL PHONE, ETC.)
- LCD DISPLAY W/ ENHANCED VIEWING ANGLE & DAYLIGHT COMPATIBLE W/ CLOCK FUNCTION
- AM/FM PLL TUNER WITH 30 PRESETS
- 2 PAIR RCA PRE AMP OUTPUTS TO ADD AN EXTERNAL AMPLIFIER
- PATENT PENDING INFINIMOUNT ADJUSTABLE SHAFT SYSTEM W/ REMOVABLE UNIVERSA BRACKET (INCLUDED)
- INSULATED BRACKET SYSTEM AND EXTERNAL SHAFT SYSTEM REDUCE ELECTRICAL NOISE INHERENT IN OLDER VEHICLES
- ADJUSTABLE FACEPLATE ANGLE, ALLOWS MOUNTING OF FACEPLATE DISPLAY TO VIRTUALLY ANY DASH
- SMALL 3.55"W x 6.57"D x 1.55"H INSTALLATION SIZE
- IR RECEIVER ON FACEPLATE (REMOTE OPTIONAL)

ORDER LINE 1-866-640-1324

**2010**

FAX LINE 1-905-850-1722

RSC - 1





**RetroSound**<sup>®</sup>  
Modern Sound for your Classic

<http://www.retrosoundcanada.com>

## RADIO SYSTEM

### MODEL ONE CHROME

Rear - mounted USB input allows you to directly play Mp3 or WMA digital files off of any commonly available and inexpensive flash/thumb drive No Ipod Needed!

**USB** **mp3**



Revolutionary patent - pending INFINIMOUNT system allows for infinite movement of bracket & shaft knobs to meet virtually any install need!

Front and Rear Aux-in analog inputs allow you to plug in any portable device (Mp3 player, satellite unit, Portable CD) The possibilities are endless!



**MODEL ONE BLACK**

#### FEATURES:

- FRONT AUX INPUT, PLUG IN ANY MP3 PLAYER OR OTHER ORTABLE DEVICE, (CELL PHONE, ETC.)
- LCD DISPLAY W/ ENHANCED VIEWING ANGLE & DAYLIGHT COMPATIBLE W/ CLOCK FUNCTION
- AM/FM PLL TUNER WITH 30 PRESETS
- 2 PAIR RCA PRE AMP OUTPUTS TO ADD AN EXTERNAL AMPLIFIER
- PATENT PENDING INFINIMOUNT ADJUSTABLE SHAFT SYSTEM W/ REMOVABLE UNIVERSAL BRACKET (INCLUDED)
- INSULATED BRACKET SYSTEM AND EXTERNAL SHAFT SYSTEM REDUCE ELECTRICAL NOISE INHERENT IN OLDER VEHICLES
- ADJUSTABLE FACEPLATE ANGLE, ALLOWS MOUNTING OF FACEPLATE DISPLAY TO VIRTUALLY ANY DASH
- SMALL 3.55"W x 6.57"D x 1.55"H INSTALLATION SIZE
- IR RECEIVER ON FACEPLATE (REMOTE INCLUDED)
- LCD DISPLAY SHOWS MP3/WMA TRACK NAME
- REAR MOUNTED USB PORT, PLUG IN ANY USB FLASH DRIVE AND PLAY MP3/WMA FILES
- FULL FUNCTION 18 KEY IR REMOTE CONTROL

ORDER LINE 1-866-640-1324

**2010**

FAX LINE 1-905-850-1722

RSC - 2



**RetroSound**<sup>®</sup>  
Modern Sound for your Classic

<http://www.retrosoundcanada.com>

## RADIO SYSTEM



## CLASSIC SOUND RADIO SYSTEM SPECIFICATIONS:

### Tuner Section

#### FM

Tuning Range (Eu & US Tuning Capable)  
Antenna Terminal  
Usable Sensitivity  
Selectivity  
Signal to Noise Ratio  
Harmonic Distortion @ 1 kHz  
Separation  
Frequency Response

87.5 - 107.9MHz  
External Antenna Connector  
12.5 dBf  
75dB @ 400kHz  
62 dB (Stereo), 67 dB (Mono)  
0.8% (Stereo), 0.5% (Monaural)  
32 dB @ 1kHz  
30 - 16,000 Hz

#### AM (Eu & US Tuning Capable)

Tuning Range  
Antenna Terminal

530 - 1710 kHz  
External Antenna Connector

### General

Dimensions (Main Body Only)  
Power Requirements  
Current Consumption  
Current Consumption  
Output Power  
(@ 14.4V @ 4 ohm @ 1% THD)  
Output Impedance  
Low Level Output (4 Channels)  
AUX Input (Rear)  
AUX Input (Front)

3.5"W x 6.7"D x 1.5"H  
10.5 - 14.4V  
Max. 10A  
< 3.5 mA  
22 x 4w RMS 60x4 Max Power  
4 - 8 ohm  
2.5V  
2V / 6 kΩ  
500 mV / 6 kΩ

ORDER LINE 1-866-640-1324

**2010**

FAX LINE 1-905-850-1722

RSC - 3



**RetroSound**<sup>®</sup>  
Modern Sound for your Classic

<http://www.retrosoundcanada.com>

**RADIO FACEPLATE**

**CHEVY IMPALA**



**RS-6162IMPALAKT**



**RS-5960IMPALAKT**



**RS-6364IMPALAKT**



**RS-6566IMPALAKT**



**RS-7085UNIVKT**

| SKU#            | YEAR    | VEHICLE |
|-----------------|---------|---------|
| RS-5960IMPALAKT | 1959-60 | IMPALA  |
| RS-6162IMPALAKT | 1961-62 | IMPALA  |
| RS-6364IMPALAKT | 1963-64 | IMPALA  |
| RS-6566IMPALAKT | 1965-66 | IMPALA  |
| RS-7085UNIVKT   | 1967-84 | IMPALA  |

**ORDER LINE 1-866-640-1324**

**2010**

**FAX LINE 1-905-850-1722**



## ACCESSORIES

### KNOBS



6885ACR



6885ABK



6885FBCRB



6885FBCRB2



6885FCRBKR



EUROKNBACR



EUROKNBABK



EUROKNBFCRBKR



EUROKNBFBKCR



DOKNOBKIT



556KNOBKIT



57KNOBKIT

### 94" REMOTE IR CABLE



### DASH HOLE CUPS



57 CHVY CUPS



68 - 67 NOVA CUPS

### REMOTE CONTROL





**RetroSound**<sup>®</sup>  
Modern Sound for your Classic

<http://www.retrosoundcanada.com>

## LOUDSPEAKERS

# RetroSound Loudspeakers

Why purchase RetroSound™ speakers over your original or "other" commercially available speakers for your classic car? Check out the exploded view below to learn more about the detail and quality that goes into each speaker we make!



**RetroSound replacement speakers have set the industry standard in OEM for your classic vehicle!**

Designed and tooled from the ground up, the speakers meet the demand of today's high performance amplifiers while maintaining factory dimensions for original location mounting and are compatible with all digital music sources. The "N" Series features 4 models that feature ultra thin 1.77" mounting profiles for fit in virtually any installation application. These 4 models with neodymium magnet structures which are 5 times more powerful than standard speaker magnets, allowing for a substantial reduction in mounting depth and feature enhanced power handling and heat dissipation characteristics. Their Dual Voice Coil design (on 3 models) allows you to connect 2 stereo channels from your radio to one speaker, providing you with maximum sound for a single speaker application!

ORDER LINE 1-866-640-1324

**2010**

FAX LINE 1-905-850-1722

RSC - 6



**RetroSound**<sup>®</sup>  
*Modern Sound for your Classic*

<http://www.retrosoundcanada.com>

## LOUDSPEAKERS

### RetroSound DVC Speaker Technical Specification



ORDER LINE 1-866-640-1324

**2010**

FAX LINE 1-905-850-1722

RSC - 7



**RetroSound**<sup>®</sup>  
Modern Sound for your Classic

<http://www.retrosoundcanada.com>

## LOUDSPEAKERS

### RetroSound SVC Speaker Technical Specification



ORDER LINE 1-866-640-1324

**2010**

FAX LINE 1-905-850-1722

RSC - 8