

GTO/CUTLASSTM

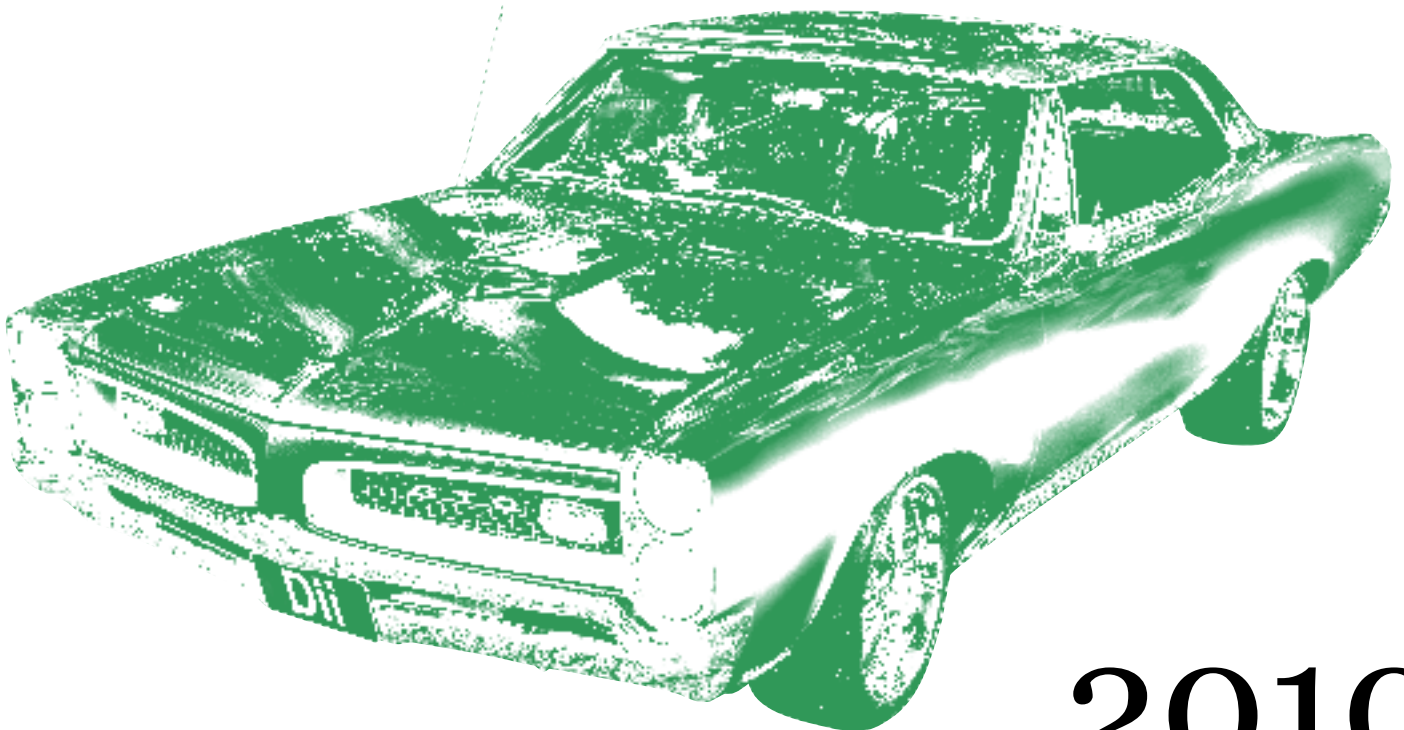

2010

Golden Leaf Automotive

GTO® / Cutlass™ Index

A

Accelerator Pedal Assembly: 24
Arm Rest Base: 20

B

Battery Clamp & Tray: 3
Body Panel, Rear: 12
Body Shims & Washers: 2
Bridge Plate, Radiator: 3
Bumper: 1
Bumper
 Brackets: 1
 Filler Panel: 1
Bushings: 26

C

Clothes Hanger: 26
Convertible Top Latch: 5
Convertible Top Well Mldgs.: 22
Crossrails, Rear: 12

D

Decal: 24
Door
 Bumpers: 19
 Glass Assembly: 17
 Handles & Relays: 18
 Hinges: 19
 Jamb Vent Grille: 19
 Latches: 19
 Lock Knobs: 19
 Shells: 16
 Skins: 15
 Striker: 19
Drip Rail Molding: 22

E

Evaporator Box: 25

F

Fenders: 2
 Front Inner: 2
Filler Panel, Rear: 12
Firewalls & Braces: 6

Floor

Pans: 7-9
Plug: 10
Support: 9

G

Gas Tank & Brace: 13
Grille & Support: 20

H

Headlamp
 Dimmer Switch: 25
 Retaining Rings: 20
 Mounting Buckets: 20
Heater Box: 25
Hood: 4
 Bumpers: 4
 Hinge: 5
 Latch Assembly: 5
 Scoop Insert: 5
Horns: 25

I

Ignition Switch Bracket: 5

L

License Plate
 Holder Bracket: 13
 Lamp: 22
Locks: 27

M

Mirrors
 Exterior: 21
 Interior: 23

N

Nose Panel: 1

P

Parking Brake Assembly: 24

Q

Quarter/Door Frame Assembly: 11
Quarter Panels: 11
Quarter Window Assembly: 17

R

Radiator Saddle: 3
Radiator Support: 3
Reveal Molding: 22
Rocker Panel Molding: 23
Roof Braces, Inner: 6

S

Scuff Plates: 22
Seat
 Assemblies: 10
 Belts: 28
 Track Assemblies: 10
Shoulder Harness Hooks: 26
Sunvisor Supports: 24

T

Tail Lamp Lenses: 25
Trunk
 Floor: 14
 Floor Braces: 15
 Floor Drop Off: 15
 Lid: 13
 Lid Moldings: 23

V

Valance, Front: 1
Vent Window Assembly: 17

W



Wheel Houses: 12
Wheel Opening Moldings: 23
Window
 Crank: 18
 Regulator: 17
 Molding, Rear: 21
Windshield Channel: 3
Windshield Molding: 21
Wiper Motor Trans. Arm: 23

Items marked with * fit GTO® and Cutlass™ of same year, unless noted otherwise.

Wholesale Only. MSRP not including Taxes, Shipping and Handling. MSRP are subject to change without notice

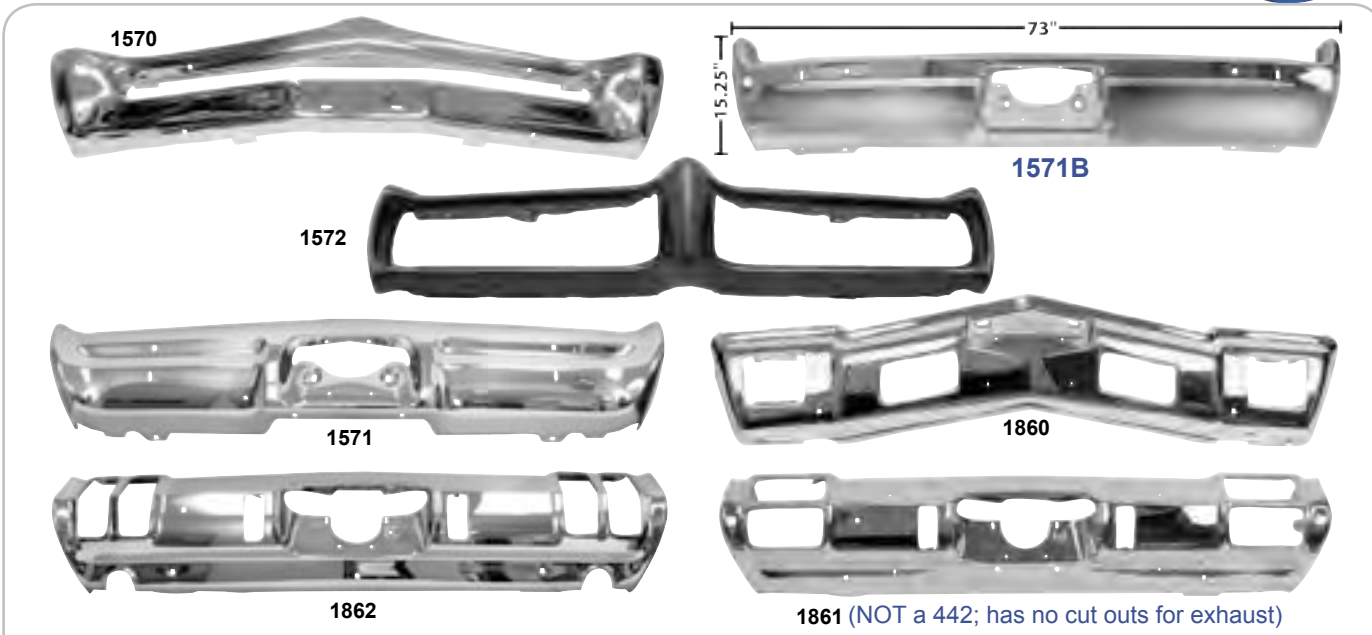
Bumpers



1570	1966-67	Front Bumper		MSRP \$459.00 ea
1571B	New 1966	Rear Bumper		MSRP \$477.00 ea
1571A	1967	Rear Bumper		MSRP \$459.00 ea
1571	1967	Rear Bumper, Tempest, LeMans		MSRP \$459.00 ea
1572	1968-69	Front Bumper, "Endura"		MSRP \$640.00 ea
1571D	1968	Rear Bumper		MSRP \$535.00 ea
1573	New 1970	Front Bumper		MSRP \$670.00 ea
1860	1970	Front Bumper, Cutlass™		MSRP \$459.00 ea
1862	1970	Rear Bumper, Cutlass™		MSRP \$459.00 ea
1861	1971-72	Rear Bumper, Cutlass™		MSRP \$459.00 ea



1529A	1967	Front Bumper Filler Panels, 7 Pcs.		MSRP \$160.00 kit
-------	------	------------------------------------	--	--------------------------

Bumper Filler



1570A	1966-67	Front Bumper Brackets, 4 Pcs		MSRP \$152.00 set
1571E	New 1966-67	Rear Bumper Brackets, 3 Pcs		MSRP \$132.00 set

Bumper Brackets



1527	1967	Nose Panel		MSRP \$104.00 ea
------	------	------------	--	-------------------------

Nose Panel



1529	1969*	Front Valance		MSRP \$229.00 ea
------	-------	---------------	--	-------------------------

Front Valance



Front Fenders

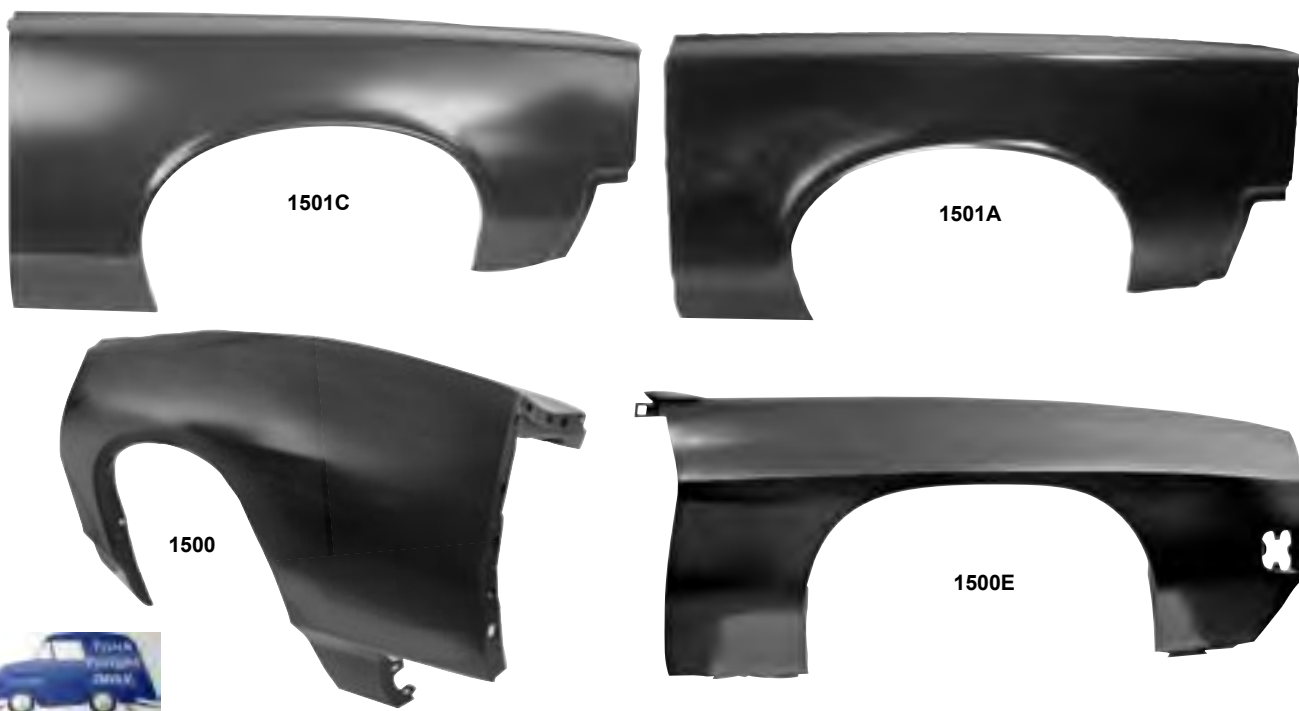

1501C	1966	Front Fender RH	MSRP \$515.00 ea
1501D	1966	Front Fender LH	MSRP \$515.00 ea
1501A	1967	Front Fender RH	MSRP \$515.00 ea
1501B	1967	Front Fender LH	MSRP \$515.00 ea
1500	1968-69	Front Fender RH	MSRP \$570.00 ea
1501	1968-69	Front Fender LH	MSRP \$570.00 ea
1500E	1970	Front Fender RH	MSRP \$570.00 ea
1500F	1970	Front Fender LH	MSRP \$570.00 ea

Front Inner Fenders

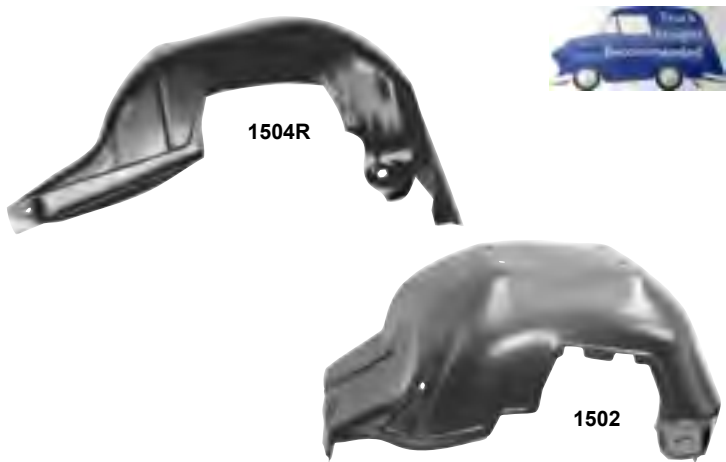

1504R	1966-67	Fr. Inner RH	MSRP \$204.00 ea
1504L	1966-67	Fr. Inner LH	MSRP \$204.00 ea
1502	1968-69	Fr. Inner RH	MSRP \$190.00 ea
1503	1968-69	Fr. Inner LH	MSRP \$190.00 ea

Body Shims

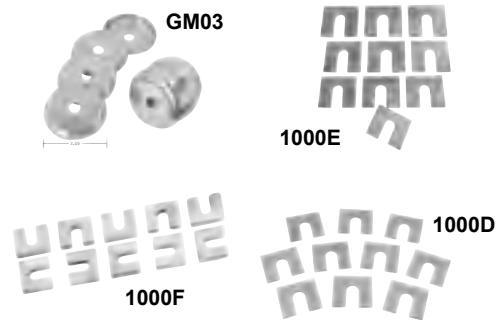

1000F	1967-72	Body Shims, 6 mm, 10 pc. set	MSRP \$12.00 set
1000D	1967-72	Body Shims, 3 mm, 10 pc. set	MSRP \$7.00 set
1000E	1965-72	Body Shims, 1.6 mm, 10 pc. set	
GM03		Body Washers, 20 pc. set	MSRP \$20.00 set

Wholesale Only. MSRP not including Taxes, Shipping and Handling. MSRP are subject to change without notice

Wholesale Only. MSRP not including Taxes, Shipping and Handling. MSRP are subject to change without notice

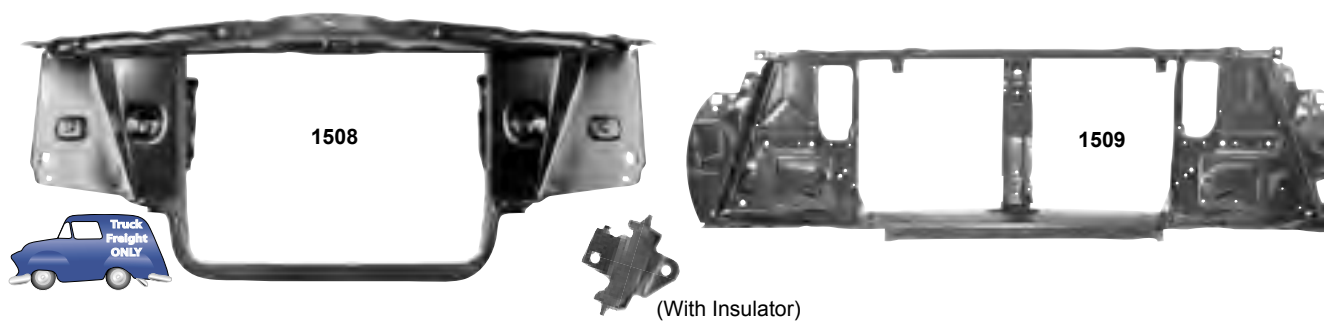

1508	1966-67	Radiator Support, O/S 3 Only, with or without A/C	MSRP \$305.00 ea
1509	1968-70	Radiator Support	MSRP \$229.00 ea
1509C	1968-72	Lower Radiator Saddle	MSRP \$19.00 ea

Radiator Supports

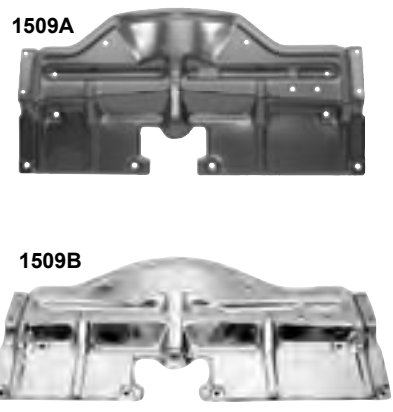

1509A	1968-69	Bridge Plate, Black	MSRP \$55.00 ea
1509B	1968-69	Bridge Plate, Chrome	MSRP \$75.00 ea

Bridge Plates

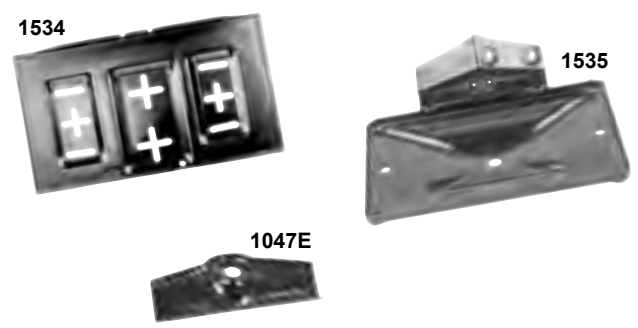

1534	1964-67	Battery Tray	MSRP \$24.00 ea
1535	1968-72	Battery Tray	MSRP \$24.00 ea
1047E	1968-72	Battery Tray Clamp	MSRP \$5.00 ea

Battery Clamp & Trays

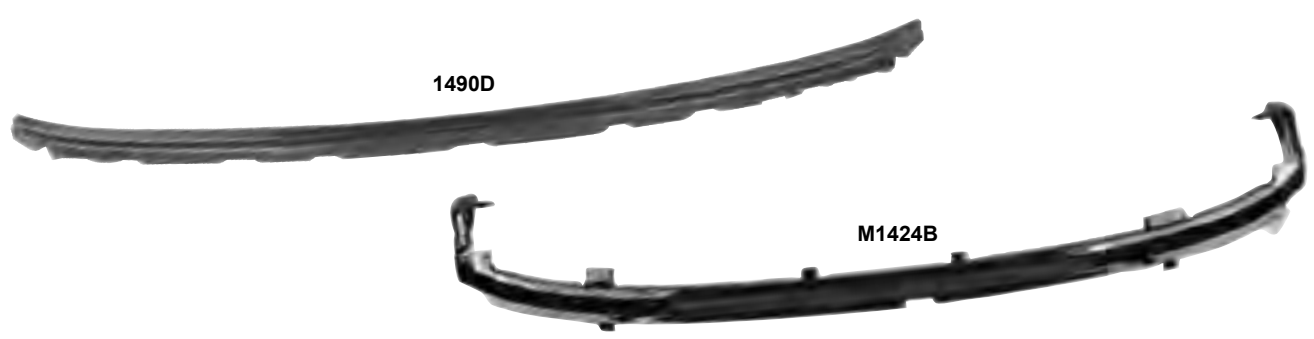

1490D	1964-67	Windshield Channel	MSRP \$55.00 ea
M1424B	1968-72	Windshield Channel	MSRP \$102.00 ea

Windshield Channels



Hoods

GM Restoration Parts 1511

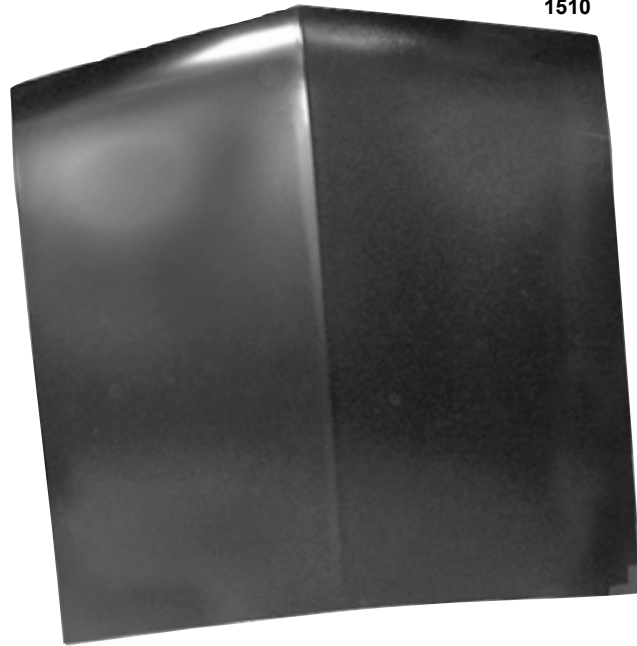

Wholesale Only. MSRP not including Taxes, Shipping and Handling. MSRP are subject to change without notice

1512	1965-67	Hood w/Scoop	MSRP \$574.00 ea
1510	1965-67	Hood (Also fits Le Mans & Tempest)	MSRP \$555.00 ea
1511	1968-70	Hood (Except Ram Air)	MSRP \$574.00 ea
1468F	1964-66	Hood Bumpers	MSRP \$9.00 pr

Wholesale Only. MSRP not including Taxes, Shipping and Handling. MSRP are subject to change without notice



1530



1531

1530	1965-67	Hood Scoop Insert	MSRP \$87.00 ea
1531	1968-70	Hood Scoop Inserts	MSRP \$114.00 pr

Scoop Inserts



1701A

1701B



1520

1521

1701A	1964-67	Hood Hinge RH	MSRP \$55.00 ea
1701B	1964-67	Hood Hinge LH	MSRP \$55.00 ea
1520	1968-72	Hood Hinge RH	MSRP \$59.00 ea
1521	1968-72	Hood Hinge LH	MSRP \$59.00 ea

Hood Hinges

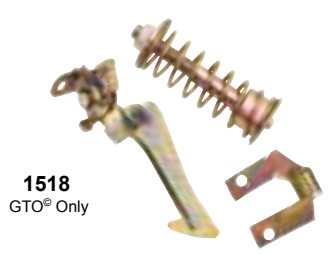

1518
GTO® Only



1519

1518	1965-67	Hood Latch Assembly	MSRP \$55.00 ea
1519	1968-70	Hood Latch Assembly	MSRP \$60.00 ea

Hood Latches



1003	1968-72	Convertible Top Latch Hook & Knuckle	MSRP \$49.00 pr
------	---------	--------------------------------------	------------------------

Cnvt. Top Latch



1516	New	1968	Ignition Switch Bracket	MSRP \$85.00 ea
------	-----	------	-------------------------	------------------------

Ign. Switch Brkt.



Roof Panel & Brackets

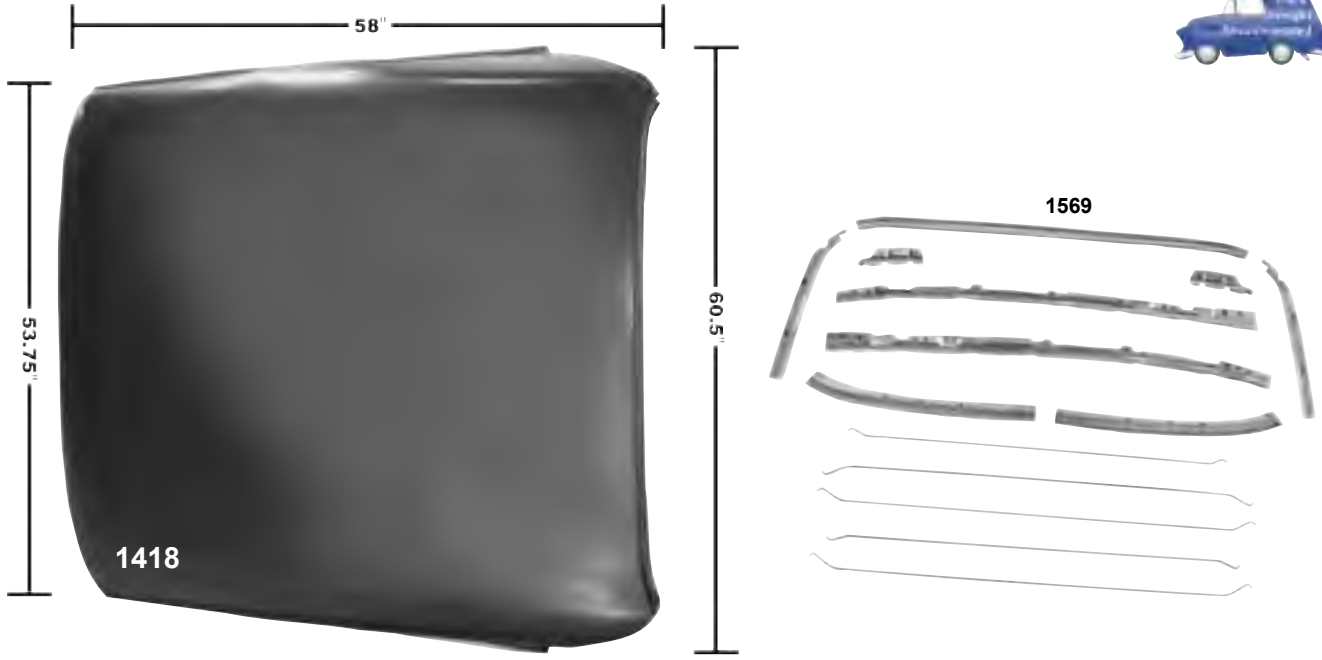

1418	1968-72	Roof Panel, Also fits '68-'72 GTO® & Cutlass™ (Excluding Cutlass™ Supreme)	MSRP \$497.00 ea
1569	1968-69	Inner Roof Bracket Kit	MSRP \$229.00 set

Firewalls

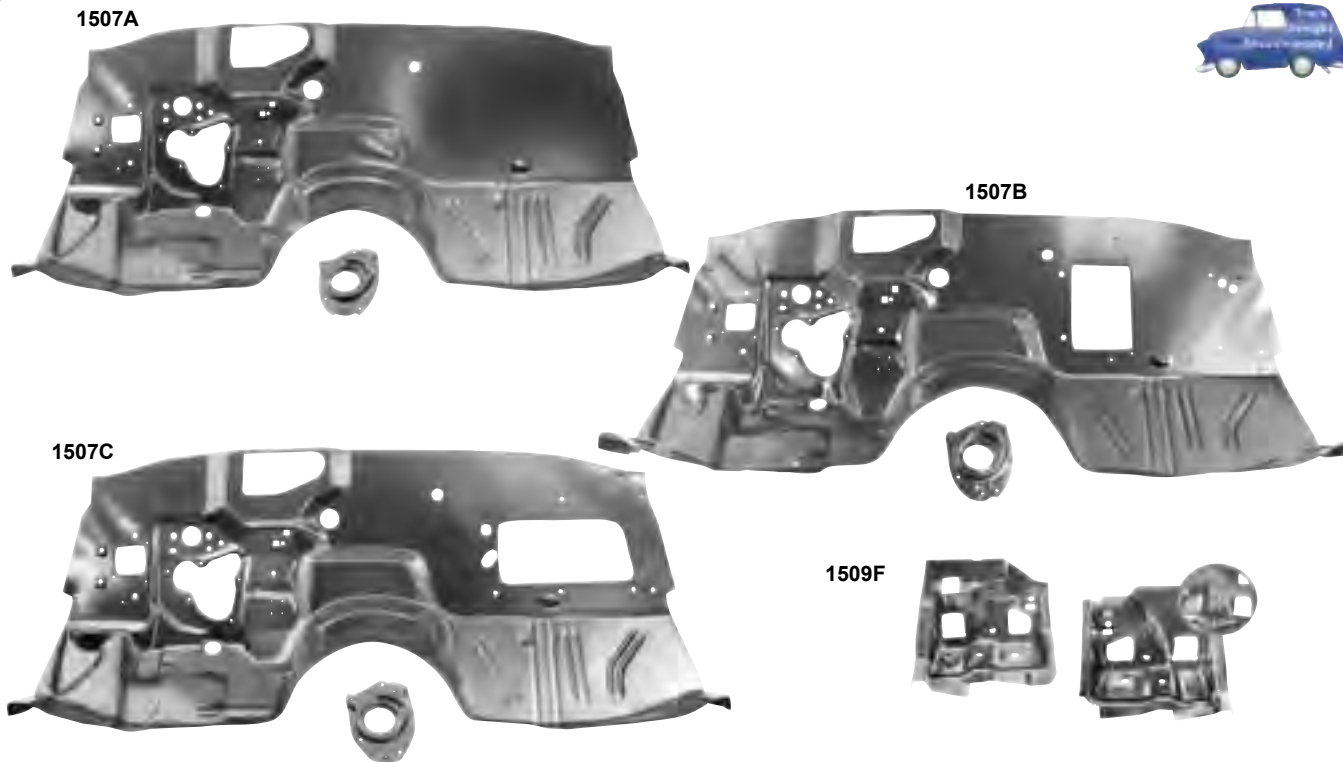

1507A	1968-69	Firewall, Heater Delete	MSRP \$477.00 ea
1507B	1968-69	Firewall, with A/C	MSRP \$477.00 ea
1507C	1968-69	Firewall, with Heater	MSRP \$477.00 ea
1509F	1968-69	Firewall Brackets	MSRP \$152.00 pr

Wholesale Only. MSRP not including Taxes, Shipping and Handling. MSRP are subject to change without notice

Wholesale Only. MSRP not including Taxes, Shipping and Handling. MSRP are subject to change without notice

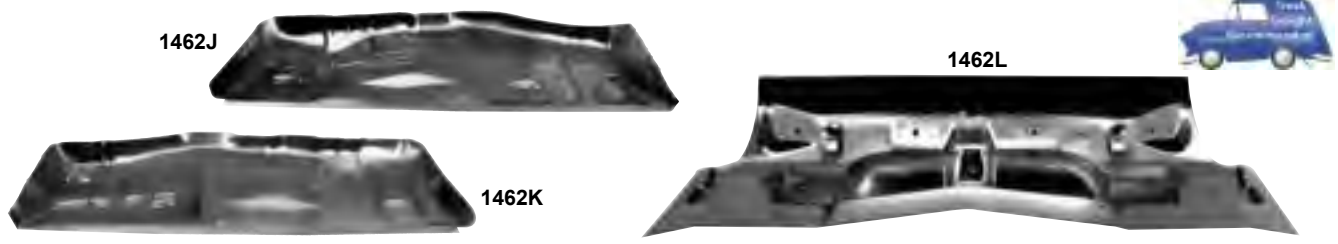

1462J	1964-67	Floor Pan - Full RH	MSRP \$94.00 ea
1462K	1964-67	Floor Pan - Full LH	MSRP \$94.00 ea
1462L	1968-72	Seat Floor Pan - Rear	MSRP \$105.00 ea

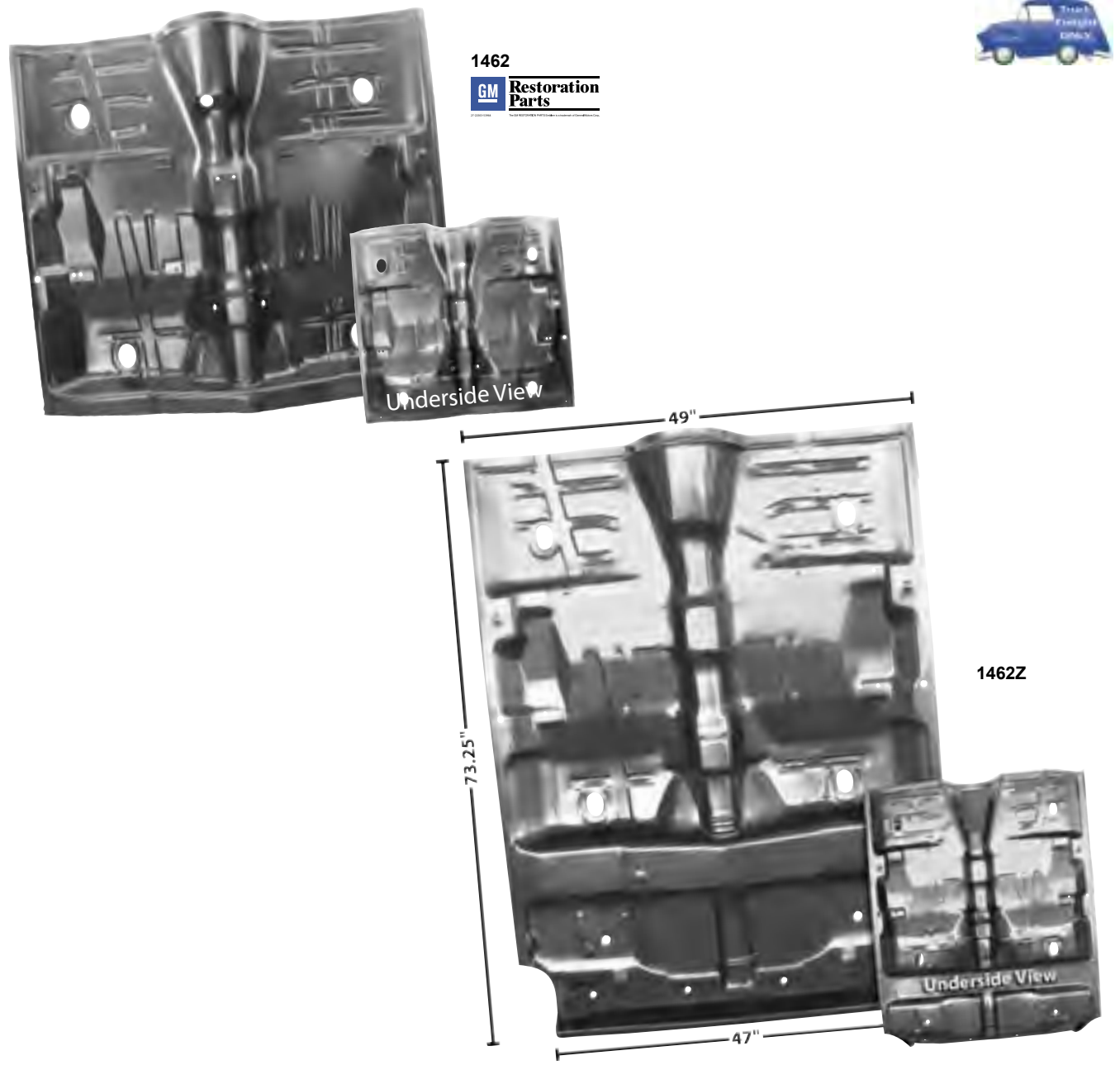

1462	1968-72*	"A" Body Full Floor Pan	MSRP \$362.00 ea
1462Z	1968-72*	"A" Body Full Floor Pan With Rear Seat Pan	MSRP \$515.00 ea



dii Exclusive



1462X



1462XA

1462X	1968-69	"A" Body Complete Floor Pan (No rocker panels)		MSRP \$1090.00 ea
1462XA	1970-72	"A" Body Complete Floor Pan (No rocker panels) Includes Front, Center & Rear Under Floor Pan Supports, and Rear Seat Floor Pan.		MSRP \$1090.00 ea



1462Y



1462YA

1462Y	1968-69*	"A" Body Complete Floor Pan With Rocker Panels		MSRP \$1435.00 ea
1462YA	1970-72	"A" Body Complete Floor Pan With Rocker Panels Includes Front, Center & Rear Under Floor Pan Supports, Rear Seat Floor Pan And Rocker Panels.		MSRP \$1435.00 ea

Wholesale Only. MSRP not including Taxes, Shipping and Handling. MSRP are subject to change without notice

Wholesale Only. MSRP not including Taxes, Shipping and Handling. MSRP are subject to change without notice

Floor Pans, continued

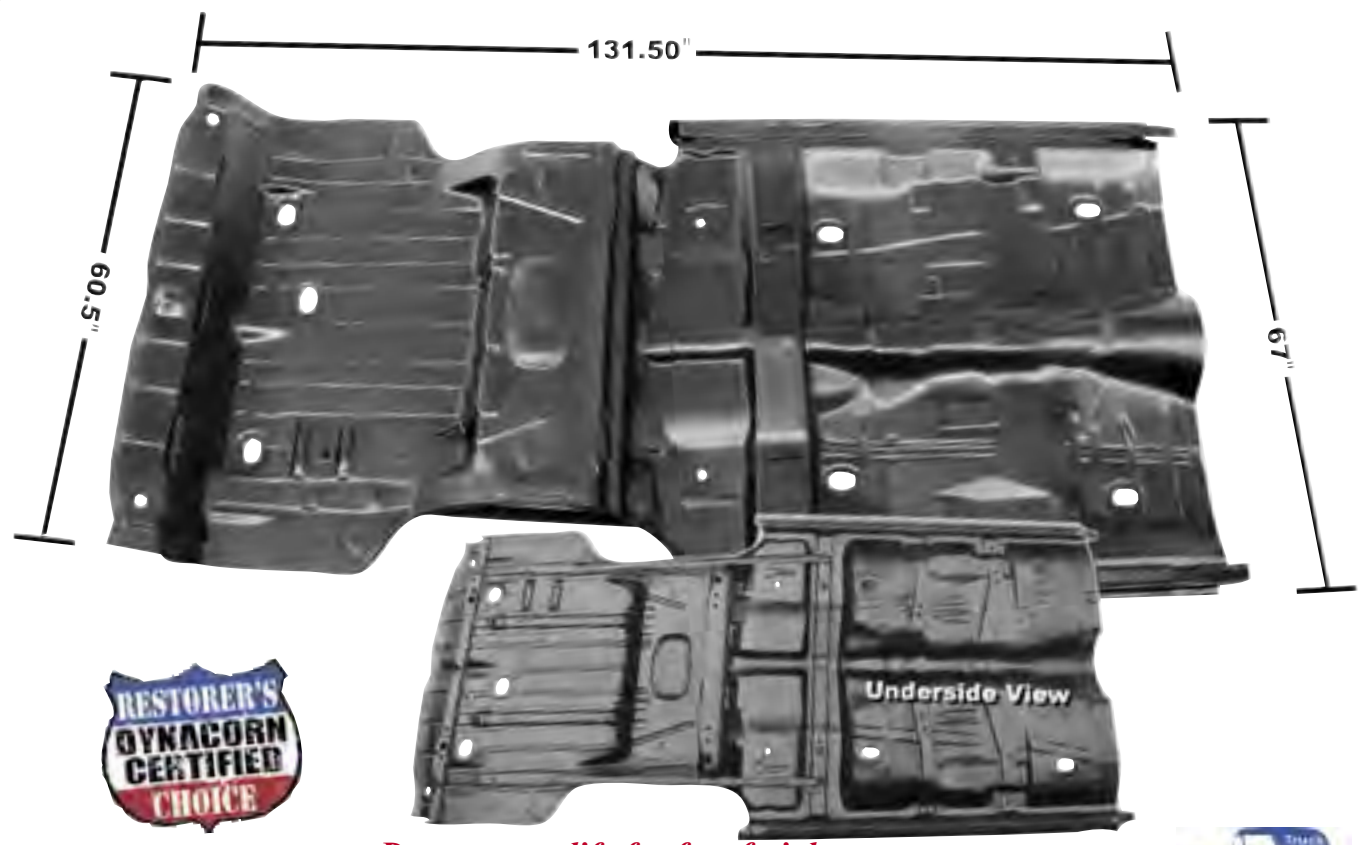

*Does not qualify for free freight program
 *non stocking item- Call for availability**



1565	1968-69	Complete Floor & Trunk Pan with Rocker Panels	MSRP \$4400.00 ea
------	---------	---	-------------------

Floor Pan Supports



1461Y	1964-69*	Under Floor Pan Support - Front	MSRP \$114.00 ea
1461Z	1964-69*	Under Floor Pan Support - Center	MSRP \$114.00 ea
1461X	1968-72*	Under Floor Pan Support - Rear	MSRP \$114.00 ea
1461YA	1970-72	Under Floor Pan Support - Front	MSRP \$152.00 ea
1461ZB	1970-72	Under Floor Pan Support - Center	MSRP \$152.00 ea



Floor Plug

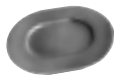

1047F 1964-72* Galvanized Floor Pan Plug
MSRP \$5.00 ea

Seat Track Assys.

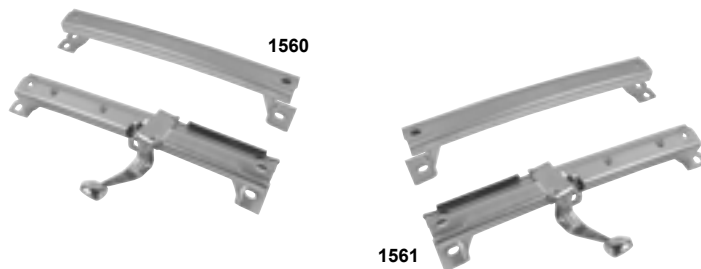

1560 1968-72* Seat Track Assy., RH 2 Pc
 1561 1968-72* Seat Track Assy., LH 2 Pc
MSRP \$124.00 set

Seat Assemblies

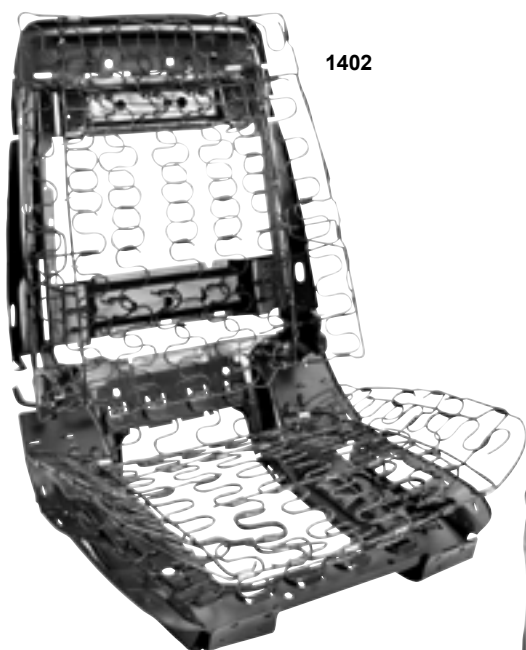

1402

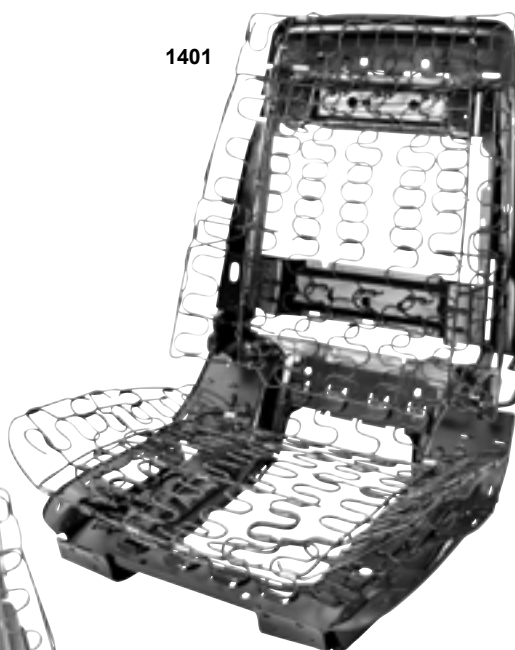

1401

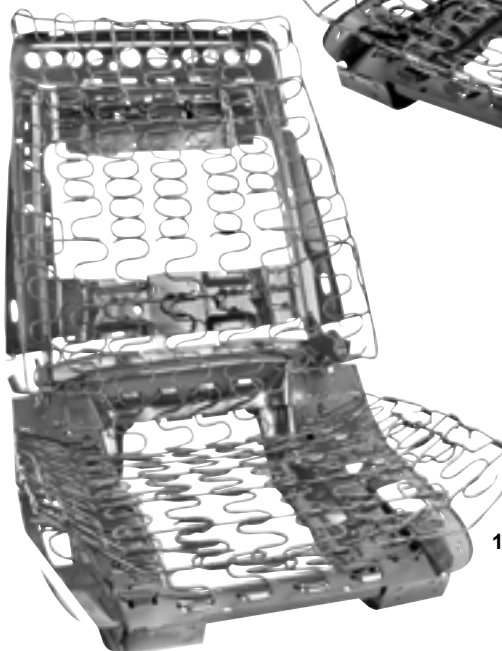

1402A

dii Exclusive

Now with Springs!

1401	1966-68*	Seat Assembly RH	MSRP \$509.00 ea
1402	1966-68*	Seat Assembly LH	MSRP \$509.00 ea
1402A	1969-72*	Seat Assembly, Fits RH & LH	MSRP \$509.00 ea

Wholesale Only. MSRP not including Taxes, Shipping and Handling. MSRP are subject to change without notice

Wholesale Only. MSRP not including Taxes, Shipping and Handling. MSRP are subject to change without notice

Quarter / Door Assemblies

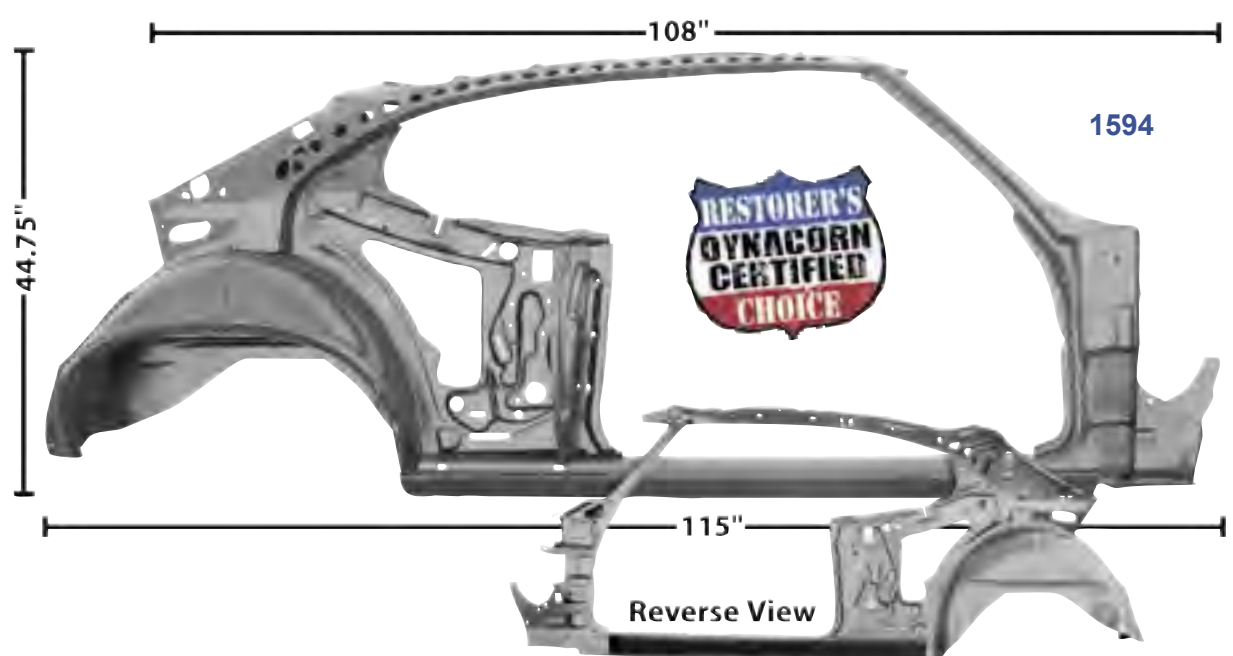

*Does Not Qualify For Free Freight Program
 * non stocking item- Call for availability **

1594	New	1968-69	Quarter/Door Assembly, RH	MSRP \$1630.00 ea
1595	New	1968-69	Quarter/Door Assembly, LH	MSRP \$1630.00 ea

Quarter Panels

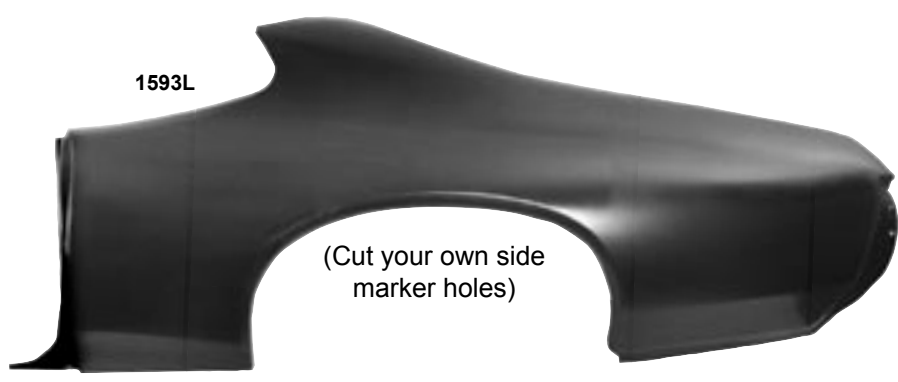

1590R	New	1966	Full Quarter Panel RH	Coming Soon!
1590L	New	1966	Full Quarter Panel LH	Coming Soon!
1591R	New	1967	Full Quarter Panel RH	Coming Soon!
1591L	New	1967	Full Quarter Panel LH	Coming Soon!
1593R		1968-69	Full Quarter Panel RH	MSRP \$630.00 ea
1593L		1968-69	Full Quarter Panel LH	MSRP \$630.00 ea

Wheelhouses

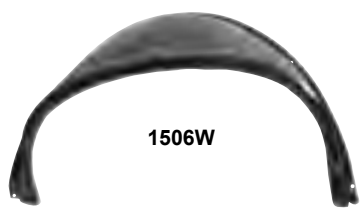

1506W

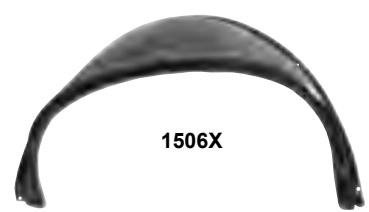

1506X



1506S

1506R	1966-67	Outer Wheelhouse RH	Coming Soon!
1506L	1966-67	Outer Wheelhouse LH	Coming Soon!
1506W	1968-69	Outer Wheelhouse RH	MSRP \$89.00 ea
1506X	1968-69	Outer Wheelhouse LH	MSRP \$89.00 ea
1506S	1968-69	Complete Wheelhouse (Inner & Outer), RH	MSRP \$324.00 ea
1506T	1968-69	Complete Wheelhouse (Inner & Outer), LH	MSRP \$324.00 ea

Rear Filler Panels



1545



1546

1545	1966-67	Rear Filler Panel	MSRP \$104.00 ea
1546	1968-69	Rear Filler Panel	MSRP \$112.00 ea

Rear Cross Rails



1544	1965	Rear Cross Rail	MSRP \$114.00 ea
------	------	-----------------	-------------------------



1544B	1968-69	Rear Cross Rail / Under Rear Deck Filler	MSRP \$80.00 ea
-------	---------	--	------------------------

Rear Body Panels

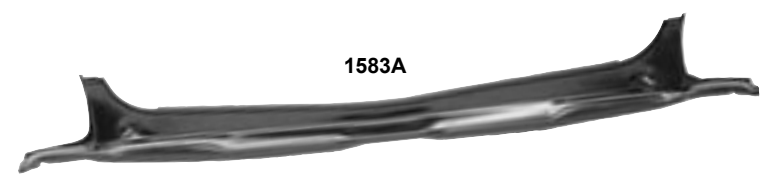

1583A

1583	New	1967	Rear Body Panel	MSRP \$220.00 ea
1583A		1968	Rear Body Panel	MSRP \$180.00 ea

Wholesale Only. MSRP not including Taxes, Shipping and Handling. MSRP are subject to change without notice

Wholesale Only. MSRP not including Taxes, Shipping and Handling. MSRP are subject to change without notice



1424B 1967-72* License Plate Holder Bracket
MSRP \$30.00 ea

License Plate Bracket



1587 New 1966-67 Gas Tank Mount Brace
MSRP \$52.00 pr
 1489K 1968-72* Gas Tank Mount Brace
MSRP \$45.00 ea

Tank Brace

dii Exclusive

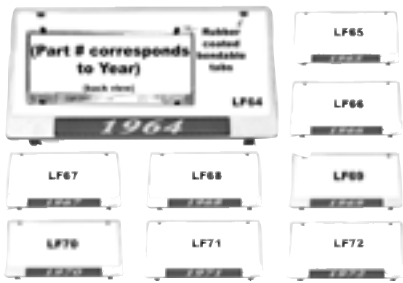

LF64 thru LF72 1964-72 License Plate Frames
MSRP \$15.00 ea

License Plate Frames



T26 1970-72 Gas Tank w/o EEC
MSRP \$165.00 ea

Gas Tank



1585 New 1967 Trunk Lid **MSRP \$362.00 ea**

Trunk Lid



Trunk Floor Pans

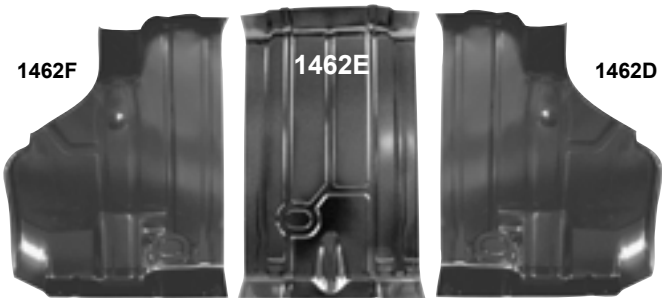

(Patch panels ONLY. Not for exacting restorations.)

1462D	1968-72	Trunk Floor Patch Panel for "A" Body, RH	MSRP \$50.00 ea
1462E	1968-72	Trunk Floor Patch Panel for "A" Body, Center	MSRP \$50.00 ea
1462F	1968-72	Trunk Floor Patch Panel for "A" Body, LH	MSRP \$50.00 ea



1586

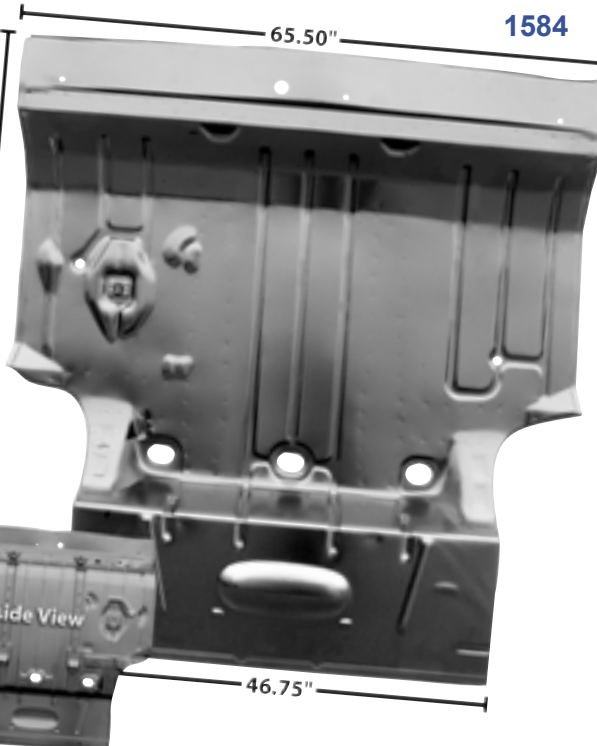
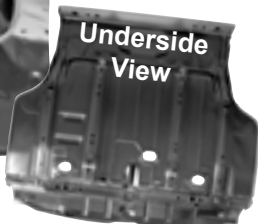

1584	New	1966-67	Complete Trunk Floor Pan	MSRP \$917.00 ea
1586		1968-70	Complete Trunk Floor Pan (trim to fit 1970 at tail lamp)	MSRP \$745.00 ea

Wholesale Only. MSRP not including Taxes, Shipping and Handling. MSRP are subject to change without notice

Wholesale Only. MSRP not including Taxes, Shipping and Handling. MSRP are subject to change without notice

Trunk Floor Drop Offs & Braces



1584A	New	1966-67	Trunk Floor Drop Off RH	MSRP \$85.00 ea
1584B	New	1966-67	Trunk Floor Drop Off LH	MSRP \$85.00 ea
1584R		1968-69	Trunk Floor Drop Off RH	MSRP \$72.00 ea
1584L		1968-69	Trunk Floor Drop Off LH	MSRP \$72.00 ea

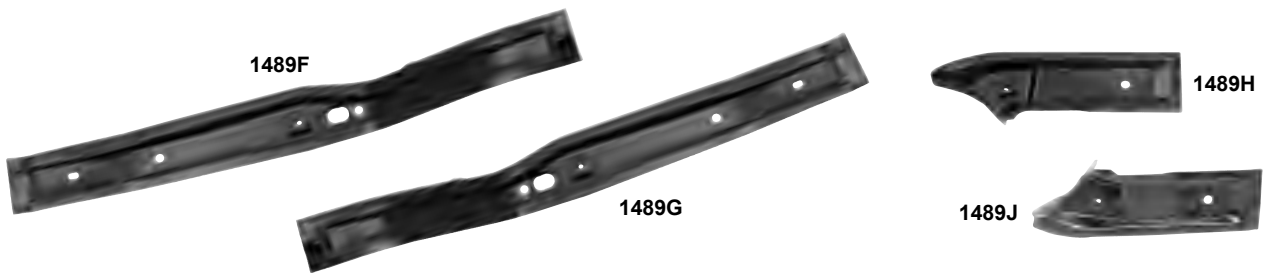

1489F		1968-72	Trunk Floor Brace RH	MSRP \$42.00 ea
1489G		1968-72	Trunk Floor Brace LH	MSRP \$42.00 ea
1489H		1964-67	Body Mount Trunk Brace RH	MSRP \$35.00 ea
1489J		1964-67	Body Mount Trunk Brace LH	MSRP \$35.00 ea

Door Skins

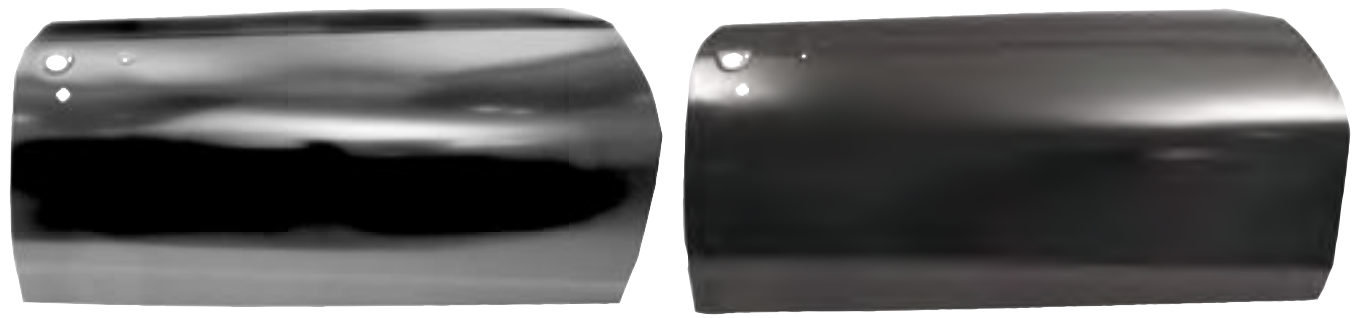

1550		1968	Door Skin RH	MSRP \$209.00 ea
1551		1968	Door Skin LH	MSRP \$209.00 ea
1552		1969	Door Skin RH	MSRP \$209.00 ea
1553		1969	Door Skin LH	MSRP \$209.00 ea



Door Shells



1554R

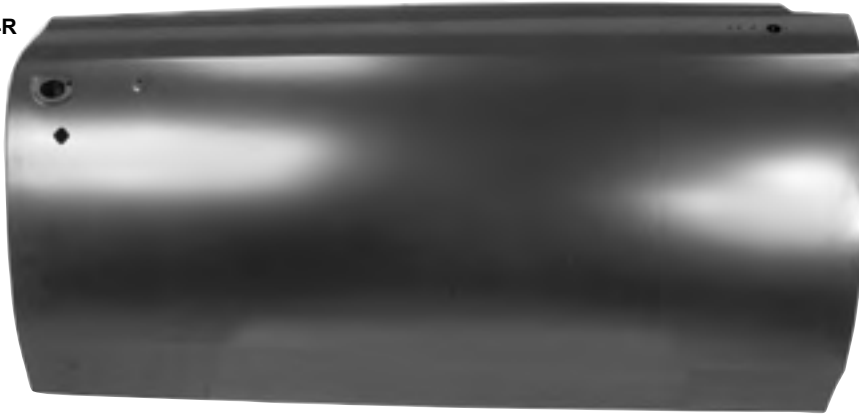

1555R



1556R

1554R	1966-67	Door Shell RH	MSRP \$555.00 ea
1554L	1966-67	Door Shell LH	MSRP \$555.00 ea
1555R	1968	Door Shell RH	MSRP \$555.00 ea
1555L	1968	Door Shell LH	MSRP \$555.00 ea
1556R	1969	Door Shell RH	MSRP \$555.00 ea
1556L	1969	Door Shell LH	MSRP \$555.00 ea

Wholesale Only. MSRP not including Taxes, Shipping and Handling. MSRP are subject to change without notice

Wholesale Only. MSRP not including Taxes, Shipping and Handling. MSRP are subject to change without notice

Window Regulators

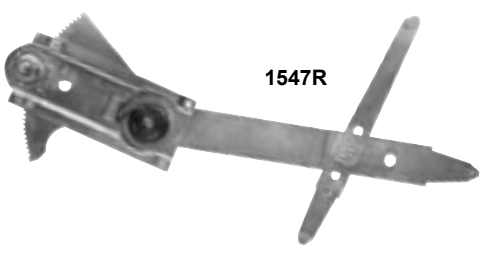

1547R

1547R	1966-67	Window Regulator - Manual RH
1547L	1966-67	Window Regulator - Manual LH

MSRP \$94.00 ea



1548L

1548R	1968	Window Regulator - Manual RH
1548L	1968	Window Regulator - Manual LH

MSRP \$94.00 ea



1549L

1549R	1968	Quarter Window Regulator - Manual RH
1549L	1968	Quarter Window Regulator - Manual LH

MSRP \$75.00 ea

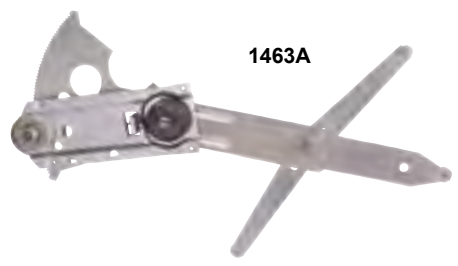

1463A

1463	1969	Window Regulator - Manual RH
1463A	1969	Window Regulator - Manual LH

MSRP \$94.00 ea

Door Glass Assembly



1555

1555	1966-67	Door Glass Assembly, RH
1556	1966-67	Door Glass Assembly, LH

MSRP \$277.00 ea

Vent & Quarter Window Assemblies



1485J

(Clear Glass)



1558

1485J	1966-67	Vent Window Assembly, RH
1485K	1966-67	Vent Window Assembly, LH

MSRP \$477.00 ea

1558	1968-69	Quarter Window Assembly, RH
1559	1968-69	Quarter Window Assembly, LH

MSRP \$305.00 ea



Exterior Door Handles



M1390	1964-67	Exterior Door Handles w/o Buttons	MSRP \$42.00 pr
M1392	1968-69	Exterior Door Handles w/o Buttons	MSRP \$49.00 pr
M1037C	1966-67	Door Handle Push Button Kit	MSRP \$10.00 kit

Interior Door Handles



M1605	1964	Single Arm Interior Door Handle	MSRP \$15.00 ea
M1604	1964	Double Arm Interior Door Handle	MSRP \$14.00 ea
M1037F	1965-67	Interior Door Handle, Standard	MSRP \$14.00 ea
M1037D	1968-72	Interior Door Handle, RH Standard	MSRP \$22.00 ea
M1037E	1968-72	Interior Door Handle, LH Standard	

Vent Window Handles

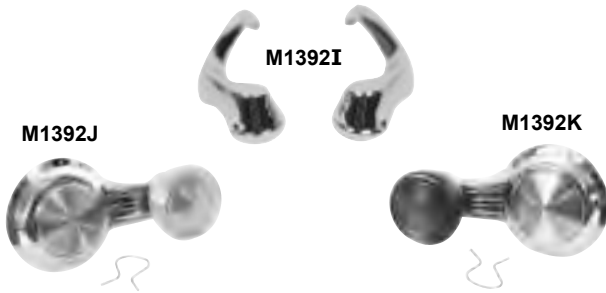

M1392I	1966-67	Vent Window Handle, Chrome	MSRP \$55.00 pr
M1392J	1968-72	Vent Window Crank, Clear Knob	MSRP \$15.00 ea
M1392K	1968-72	Vent Window Crank, Black Knob	MSRP \$15.00 ea

Window Cranks



M1382	1965-66	Window Crank	MSRP \$25.00 ea
M1382A	1967	Window Crank	MSRP \$25.00 ea
M1037A	1969-72	Window Crank, Black Knob	MSRP \$5.00 ea
M1037B	1969-72	Window Crank, Clear Knob	MSRP \$5.00 ea

Handle Relays

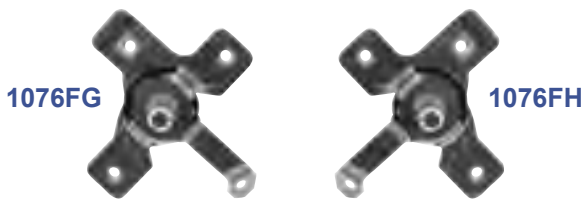

1076FG	New	1968-69	Door Handle Relay, RH
1076FH	New	1968-69	Door Handle Relay, LH
MSRP \$29.00 ea			

Wholesale Only. MSRP not including Taxes, Shipping and Handling. MSRP are subject to change without notice

Wholesale Only. MSRP not including Taxes, Shipping and Handling. MSRP are subject to change without notice

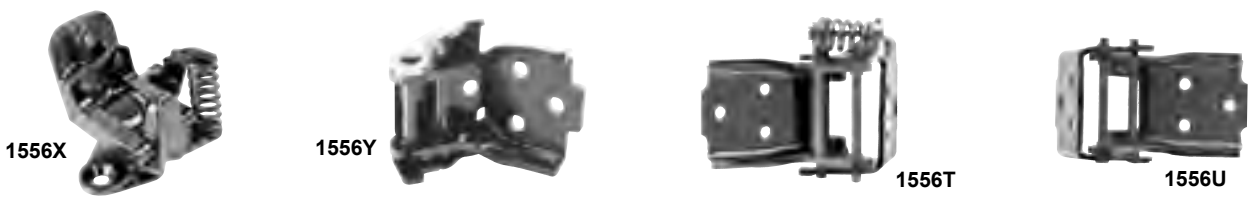

1556W	1966-67*	Door Hinge, Lower RH	MSRP \$75.00 ea
1556X	1966-67*	Door Hinge, Lower LH	MSRP \$75.00 ea
1556Y	1966-67*	Door Hinge, Upper RH	MSRP \$65.00 ea
1556Z	1966-67*	Door Hinge, Upper LH	MSRP \$65.00 ea
1556S	1968-72*	Door Hinge, Lower RH	MSRP \$75.00 ea
1556T	1968-72*	Door Hinge, Lower LH	MSRP \$75.00 ea
1556U	1968-72*	Door Hinge, Upper RH/LH	MSRP \$75.00 ea

Door Hinges

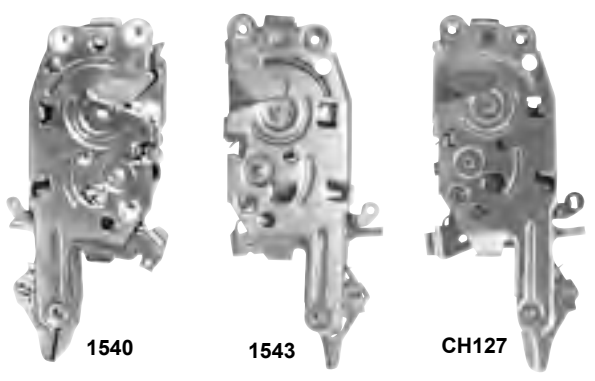

1542	1966-67	Door Latch RH	MSRP \$85.00 ea
1543	1966-67	Door Latch LH	
1540	1968-69	Door Latch RH, GTO®	MSRP \$85.00 ea
1541	1968-69	Door Latch LH, GTO®	
CH128	1970	Door Latch RH, Cutlass™	MSRP \$74.00 ea
CH127	1970	Door Latch LH, Cutlass™	

Door Latches

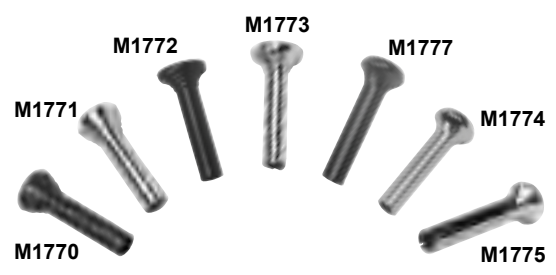

M1770	1964-66	Door Lock Knob, Black	MSRP \$5.00 pr
M1771	1964-66	Door Lock Knob, Chrome	
M1772	1967	Door Lock Knob, Black	MSRP \$5.00 pr
M1773	1967	Door Lock Knob, Chrome	
M1777	1968-69	Door Lock Knob, Black	MSRP \$5.00 pr
M1774	1968-69	Door Lock Knob, Chrome	
M1775	1970-72	Door Lock Knob, Chrome	MSRP \$5.00 pr

Door Lock Knobs

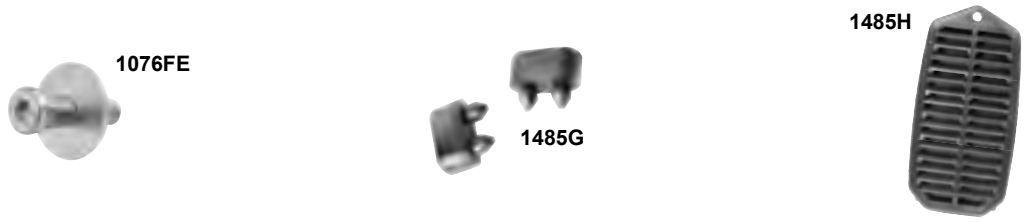

1076FE	1965-72	Door Lock Striker	MSRP \$17.00 ea
1485G	1968-72	Door Bumpers	MSRP \$4.00 pr
1485H	1970-72	Door Jamb Vent Grille	MSRP \$20.00 ea

Door Miscellaneous



Front Arm Rest Bases

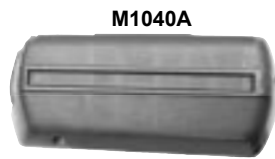
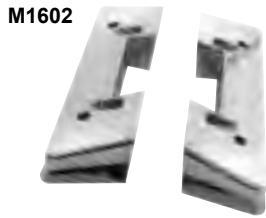

M1602	1964-67	Arm Rest Base, Chrome	MSRP \$34.00 pr
M1040	1968-72	Arm Rest Base, Black RH	MSRP \$17.00 ea
M1040A	1968-72	Arm Rest Base, Black LH	MSRP \$17.00 ea
M1040B	1968-72	Arm Rest Base, Red	MSRP \$37.00 pr
M1040C	1968-72	Arm Rest Base, Medium Blue	MSRP \$37.00 pr
M1040D	1968-72	Arm Rest Base, Ivy Gold	MSRP \$37.00 pr
M1040E	1968-72	Arm Rest Base, White	MSRP \$37.00 pr
M1040F	1968-72	Arm Rest Base, Dark Blue	MSRP \$37.00 pr
M1040G	1968-72	Arm Rest Base, Dark Green	MSRP \$37.00 pr

Rear Arm Rest Bases

dii Exclusive



M1040L



M1040J

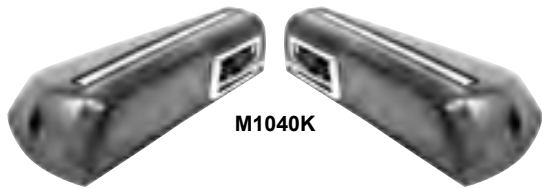

M1040K

M1040L	1966-67	Rear Arm Rest	MSRP \$152.00 pr
M1040J	1968-69	Rear Arm Rest (no trim) Ash Tray & Pad	MSRP \$152.00 pr
M1040K	1968-69	Rr Arm Rest, Chrome Trim Ash Tray & Pad	MSRP \$167.00 pr

Grille & Components

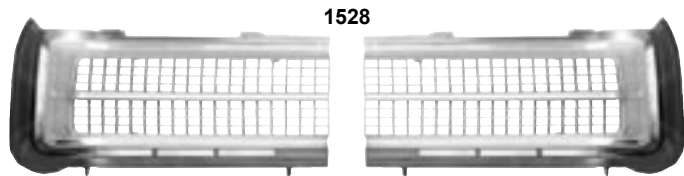

1528



1509E

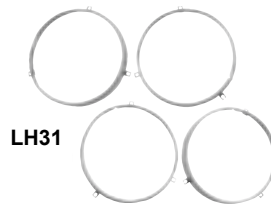

LH31

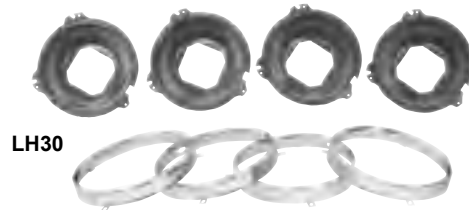

LH30

LH30	1966-70	Headlamp Mount Buckets w/Rings, 8 pcs.	MSRP \$130.00 set
LH31	1967-70	Headlamp Retaining Rings, 4 pcs.	MSRP \$24.00 set
1509E	1968	Grille Support	MSRP \$42.00 ea
1528	1969	Grille RH/LH	MSRP \$247.00 pr

Wholesale Only. MSRP not including Taxes, Shipping and Handling. MSRP are subject to change without notice

Wholesale Only. MSRP not including Taxes, Shipping and Handling. MSRP are subject to change without notice

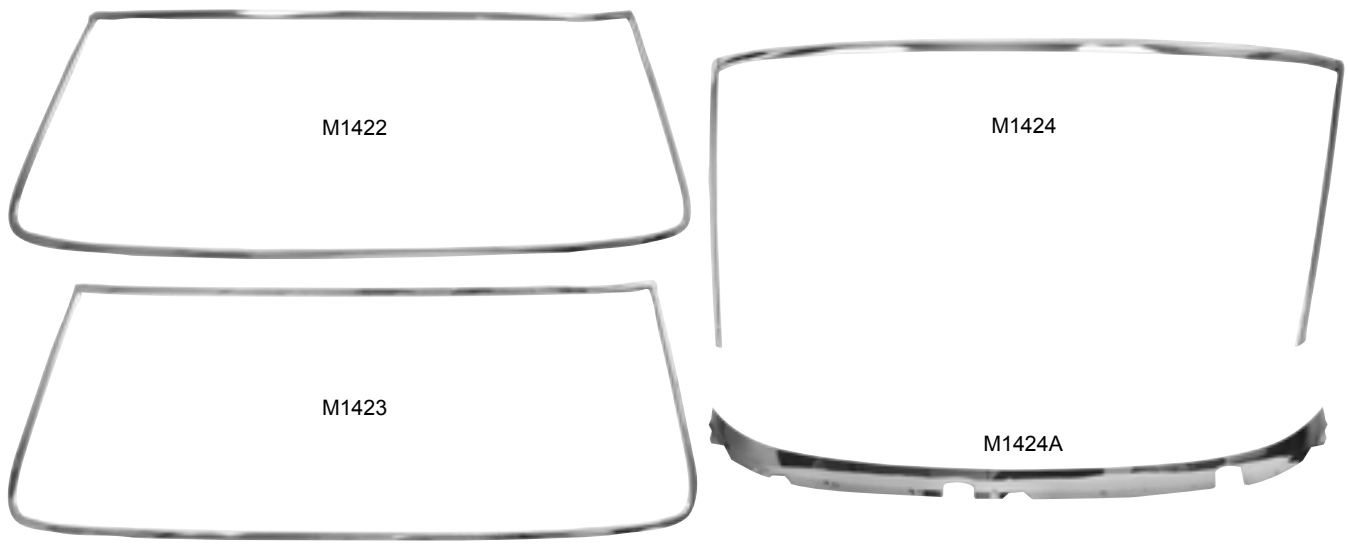

M1422	1964-65	Windshield Moldings, 5 pcs	MSRP \$229.00 set
M1423	1966-67	Windshield Moldings, 5 pcs	MSRP \$229.00 set
M1424	1968-72	Windshield Moldings, 3 pcs	MSRP \$100.00 set
M1424A	1968-72	Windshield Molding Lower	MSRP \$184.00 ea

Windshield Moldings



M1424Y	New	1966-67	Rear Window Moldings, 5pcs (Buick™, Olds™ & Pontiac™ Hard Tops)	MSRP \$239.00 set
--------	-----	---------	--	--------------------------



M1425	1966-67	Rear Window Moldings, 4pcs	MSRP \$239.00 set
-------	---------	----------------------------	--------------------------

Rear Window Moldings



1580



1581

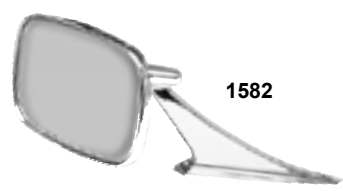

1582

1580	1964-66	Exterior Mirror	MSRP \$52.00 ea
------	---------	-----------------	------------------------

1581	1967-68	Exterior Mirror	MSRP \$62.00 ea
1582	1969-72	Exterior Mirror	

Exterior Mirrors



Convertible Well Moldings

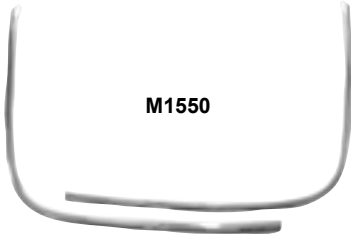

M1550



M1551

M1550 1966-67 Convertible Top Well Moldings, Tempest

MSRP \$202.00 set

M1551 1966-67 Convertible Top Well Moldings, GTO®/LeMans

MSRP \$202.00 set

Scuff Plates



M1340

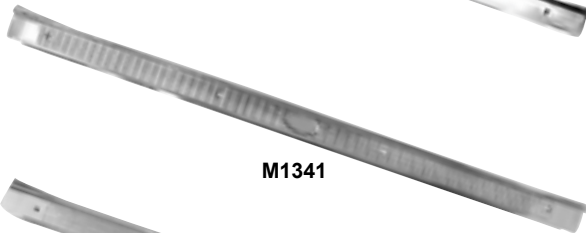

M1341



M1342

M1340 1964-67 Scuff Plate w/o Ribs

M1341 1964-67 Scuff Plate w/ Ribs

M1342 1968-72 Scuff Plate RH

M1343 1968-72 Scuff Plate LH

MSRP \$27.00 ea

M1342A New 1968-72 Scuff Plates, Stainless, Pr.

Coming Soon!

Drip Rail Molding



M1500

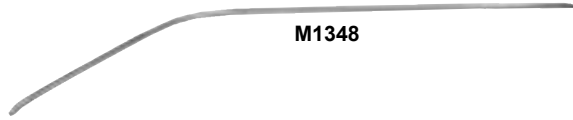

M1348



M1501

M1500 1964-65 Drip Rail Moldings, 6 pc.

MSRP \$130.00 set

M1348 1966-67* Drip Rail Moldings, 2 pc

MSRP \$69.00 set

M1501 1968-72 Drip Rail Moldings, 6 pc.

MSRP \$130.00 set

Reveal Moldings

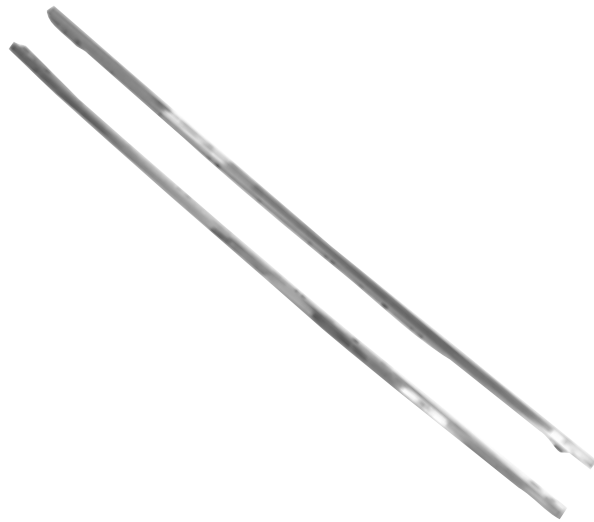

M1540 1966-67 Front Door Ledge Reveal Moldings

MSRP \$132.00 pr

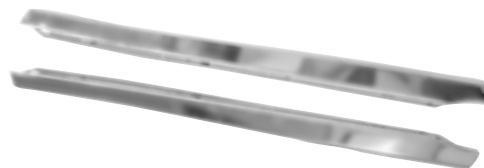

M1541 1966-67 Quarter Ledge Reveal Moldings

MSRP \$84.00 pr

Wholesale Only. MSRP not including Taxes, Shipping and Handling. MSRP are subject to change without notice

Wholesale Only. MSRP not including Taxes, Shipping and Handling. MSRP are subject to change without notice

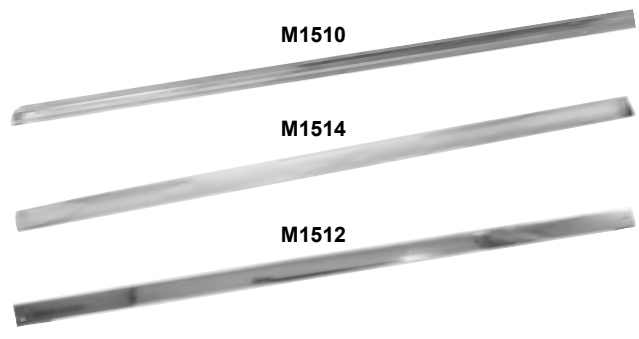

Rocker Panel Molding

M1510	1964-65	Rocker Molding RH
M1511	1964-65	Rocker Molding LH
M1514	1966	Rocker Molding RH (Also fits 1967 Le Mans)
M1515	1966	Rocker Molding LH (Also fits 1967 Le Mans)
M1512	1970-72	Rocker Molding RH
M1513	1970-72	Rocker Molding LH

MSRP \$80.00 ea

Rocker Panel Molding



Wheel Opening Moldings

M1560	1964-65	Wheel Opening Moldings, 4 pcs.
M1561	1966-67	Wheel Opening Moldings, 4 pcs.

MSRP \$285.00 set

Wheel Opening Moldings



Trunk Lid Mldg.

M1530	1967	Trunk Lid Molding
M1531	New	Trunk Lid Extension Moldings

MSRP \$94.00 ea
MSRP \$102.00 pr

Trunk Lid Mldg.

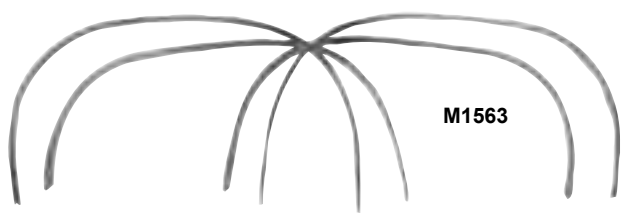

Wheel Opening Moldings

M1562	1968-69	Wheel Opening Moldings, 4 pcs.
M1563	1970-72	Wheel Opening Moldings, 4 pcs.

MSRP \$285.00 set

Wiper Motor Transmission Arm



Interior Mirrors

911366	1968	Rearview Mirror 10"
M1035A	1969-71	Rearview Mirror 12"

MSRP \$47.00 ea
MSRP \$54.00 ea

Interior Mirrors



Wiper Motor Transmission Arm

1507G	New	1968-69	Wiper Motor Transmission Arm
-------	-----	---------	------------------------------

MSRP \$170.00 ea

Visor Support



M1338 1964-72 Sunvisor Support
MSRP \$20.00 ea

Sill Decal



FL01 "Body by Fisher" Decal
MSRP \$2.00 ea

Accelerator Pedal Assemblies



1499 1968-69 Accelerator Pedal Assembly
MSRP \$74.00 ea



1499A 1970-72 Accelerator Pedal Assembly
MSRP \$74.00 ea

Parking Brake Assemblies



1525

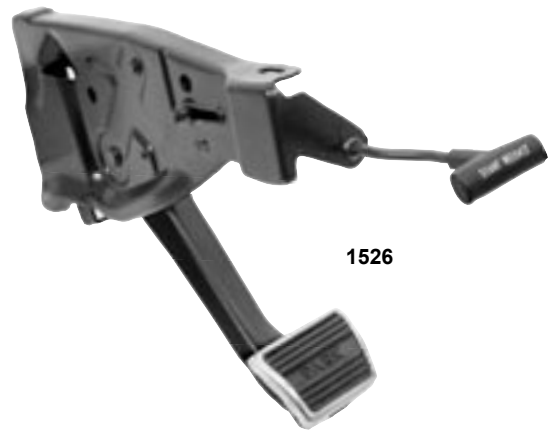

1526

1525 1965-67 Parking Brake Assembly
MSRP \$114.00 ea

1526 1968-72 Parking Brake Assembly
MSRP \$114.00 ea

Wholesale Only. MSRP not including Taxes, Shipping and Handling. MSRP are subject to change without notice

Wholesale Only. MSRP not including Taxes, Shipping and Handling. MSRP are subject to change without notice

Heater Boxes



1536

1536	1966-67	Heater Box - Standard Non-Air	MSRP \$342.00 ea
1517	New	1968-69	Heater Box - With A/C
			Coming Soon!

Tail Lamp Lenses



1596	1969	Tail Lamp Lenses	MSRP \$209.00 pr
------	------	------------------	------------------

Horns

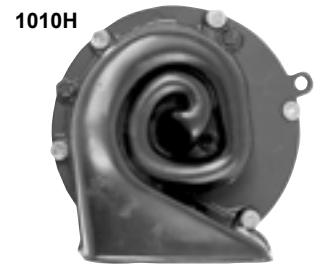

1010H

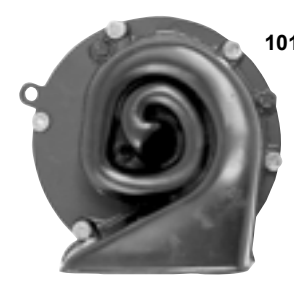

1010L

1010H	1964-72	Horn - High	MSRP \$75.00 ea
1010L	1964-72	Horn - Low	

Evaporator Box



1400	1968-72	Evaporator Box	MSRP \$267.00 ea
------	---------	----------------	------------------

Headlamp Switch



LH01	1966-70	Headlamp Dimmer Switch	MSRP \$7.00 ea
------	---------	------------------------	----------------

License Plate Lamps

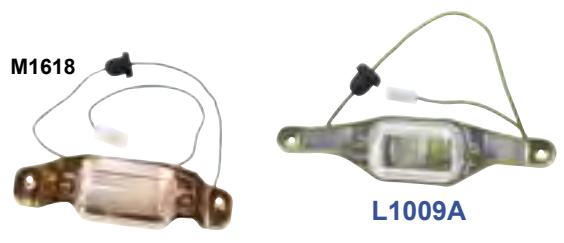

M1618	1966-72	License Plate Lamp	MSRP \$27.00 ea
L1009A	New 1970	License Plate Lamp, Cutlass™	MSRP \$42.00 ea

Miscellaneous

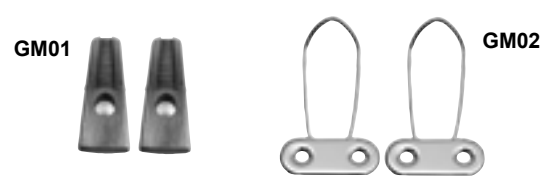

GM01	1966-70	Clothes Hangers	MSRP \$15.00 pr
GM02	1966-70	Shoulder Harness Hooks	MSRP \$10.00 pr

Bushings



M1450	1965-67	Radiator Support Bushings	MSRP \$20.00 kit
M1451	1968-72	Radiator Support Bushings	MSRP \$20.00 kit
M1452	1964-67	Coupe Body Bushings	MSRP \$65.00 kit
M1453	1968-72	Coupe Body Bushings	MSRP \$97.00 kit



M1452A	1964-67	Convertible Body Bushings	MSRP \$77.00 kit
M1454	1968-72	Convertible Body Bushings	MSRP \$105.00 kit

Wholesale Only. MSRP not including Taxes, Shipping and Handling. MSRP are subject to change without notice

Wholesale Only. MSRP not including Taxes, Shipping and Handling. MSRP are subject to change without notice

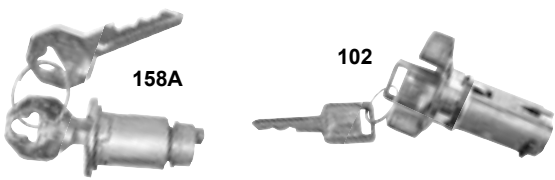

158	1962-65	Octagon	MSRP \$12.00 kit
158A	1962-65	Original	MSRP \$15.00 kit
100	1966-67	Later	MSRP \$14.00 kit
100A	1966-67	Original	MSRP \$17.00 kit
101	1968	Later	MSRP \$17.00 kit
101A	1968	Original	MSRP \$20.00 kit
102	1969-78	Later	MSRP \$17.00 kit

Ignition Locks

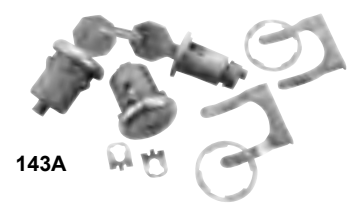

143A	1962-65	Original	MSRP \$54.00 kit
104	1966-67	Later	MSRP \$30.00 kit
104A	1966-67	Original	MSRP \$37.00 kit
105	1968	Later	MSRP \$37.00 kit
105A	1968	Original	MSRP \$44.00 kit
106	1969-78	Later	MSRP \$37.00 kit

Ignition & Door Lock Kits

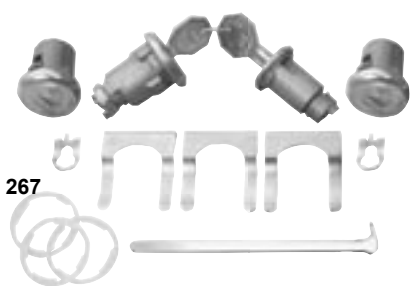

269	1962	Original	MSRP \$55.00 kit
267	1964-65	Original	MSRP \$55.00 kit
276	1966-67	Original	MSRP \$55.00 kit

Ign., Door & Trunk Kits

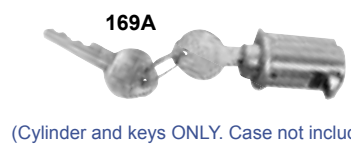

169	1964-67	Later	MSRP \$25.00 kit
169A	1964-67	Original	MSRP \$34.00 kit
146	1968-69	Later	MSRP \$25.00 kit
183	1970-75	Later	MSRP \$30.00 kit

Glovebox

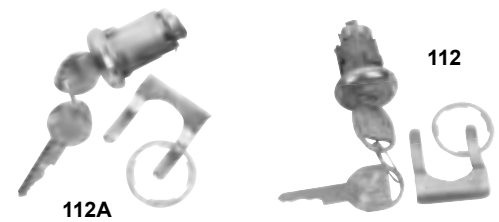

112	1963-65	Later	MSRP \$17.00 kit
112A	1963-65	Original	MSRP \$22.00 kit
113	1966-67	Later	MSRP \$17.00 kit
113A	1966-67	Original	MSRP \$22.00 kit

Trunk Locks

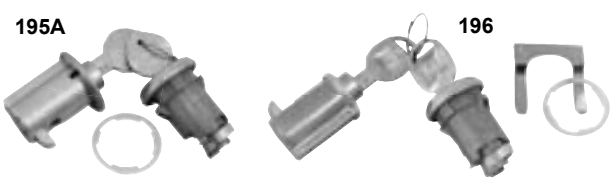

(Cylinder and keys ONLY. Case not included.)

195	1962	Later	MSRP \$39.00 kit
195A	1962	Original	MSRP \$47.00 kit
172	1963-65	Later	MSRP \$37.00 kit
172A	1963-65	Original	MSRP \$42.00 kit
196	1966-67	Later	MSRP \$39.00 kit
196A	1966-67	Original	MSRP \$47.00 kit
198	1970-75	Later	MSRP \$40.00 kit

Trunk & Glovebox Kits



Kits come complete with lock, keys, spring, shaft, bracket, & gasket. (non-GM keys)

1575	1964-65	Later	MSRP \$14.00 kit
1576	1966-67	Original	MSRP \$15.00 kit

Trunk Kits



RetroSound

Modern Sound for Your Classic

CLASSIC CAR RADIO & ACCESSORIES

GTO / CUTLASS



2010 RetroSound Catalog Version 1

ORDER LINE 1-866-640-1324

2010

FAX LINE 1-905-850-1722



RetroSound[®]
Modern Sound for your Classic

<http://www.retrosoundcanada.com>

INDEX

Index

RADIO SYSTEM

CLASSIC SOUND:.....	RSC-1
MODEL ONE:.....	RSC-2
RADIO SPECIFICATION:.....	RSC-3
FACEPLATE:.....	RSC-4
ACCESSORIES:	
KNOBS:.....	RSC-5
DASH HOLE CUPS:.....	RSC-5
REMOTE:.....	RSC-5
IR CABLE:.....	RSC-5

LOUDSPEAKERS

DESCRIPTION:.....	RSC-6
DVC SPEAKER:.....	RSC-7
SVC SPEAKER:.....	RSC-8



RetroSound[®]
Modern Sound for your Classic

<http://www.retrosoundcanada.com>

RADIO SYSTEM



Revolutionary patent - pending
INFINIMOUNT system allows for
infinite movement of bracket & shaft
knobs to meet virtually any install need!

Front and Rear Aux-in analog inputs
allow you to plug in any portable device
(Mp3 player, satellite unit, Portable CD)
The possibilities are endless!

CS-900

FEATURES:

- FRONT AUX INPUT, PLUG IN ANY MP3 PLAYER OR OTHER PORTABLE DEVICE, (CELL PHONE, ETC.)
- LCD DISPLAY W/ ENHANCED VIEWING ANGLE & DAYLIGHT COMPATIBLE W/ CLOCK FUNCTION
- AM/FM PLL TUNER WITH 30 PRESETS
- 2 PAIR RCA PRE AMP OUTPUTS TO ADD AN EXTERNAL AMPLIFIER
- PATENT PENDING INFINIMOUNT ADJUSTABLE SHAFT SYSTEM W/ REMOVABLE UNIVERSA BRACKET (INCLUDED)
- INSULATED BRACKET SYSTEM AND EXTERNAL SHAFT SYSTEM REDUCE ELECTRICAL NOISE INHERENT IN OLDER VEHICLES
- ADJUSTABLE FACEPLATE ANGLE, ALLOWS MOUNTING OF FACEPLATE DISPLAY TO VIRTUALLY ANY DASH
- SMALL 3.55"W x 6.57"D x 1.55"H INSTALLATION SIZE
- IR RECEIVER ON FACEPLATE (REMOTE OPTIONAL)

ORDER LINE 1-866-640-1324

2010

FAX LINE 1-905-850-1722

RSC - 1



RetroSound[®]
Modern Sound for your Classic

<http://www.retrosoundcanada.com>

RADIO SYSTEM

Rear - mounted USB input allows you to directly play Mp3 or WMA digital files off of any commonly available and inexpensive flash/thumb drive
No Ipod Needed!

USB **mp3**



MODEL ONE CHROME

Revolutionary patent - pending INFINIMOUNT system allows for infinite movement of bracket & shaft knobs to meet virtually any install need!

Front and Rear Aux-in analog inputs allow you to plug in any portable device (Mp3 player, satellite unit, Portable CD)
The possibilities are endless!



MODEL ONE BLACK

FEATURES:

- FRONT AUX INPUT, PLUG IN ANY MP3 PLAYER OR OTHER PORTABLE DEVICE, (CELL PHONE, ETC.)
- LCD DISPLAY W/ ENHANCED VIEWING ANGLE & DAYLIGHT COMPATIBLE W/ CLOCK FUNCTION
- AM/FM PLL TUNER WITH 30 PRESETS
- 2 PAIR RCA PRE AMP OUTPUTS TO ADD AN EXTERNAL AMPLIFIER
- PATENT PENDING INFINIMOUNT ADJUSTABLE SHAFT SYSTEM W/ REMOVABLE UNIVERSAL BRACKET (INCLUDED)
- INSULATED BRACKET SYSTEM AND EXTERNAL SHAFT SYSTEM REDUCE ELECTRICAL NOISE INHERENT IN OLDER VEHICLES
- ADJUSTABLE FACEPLATE ANGLE, ALLOWS MOUNTING OF FACEPLATE DISPLAY TO VIRTUALLY ANY DASH
- SMALL 3.55"W x 6.57"D x 1.55"H INSTALLATION SIZE
- IR RECEIVER ON FACEPLATE (REMOTE INCLUDED)
- LCD DISPLAY SHOWS MP3/WMA TRACK NAME
- REAR MOUNTED USB PORT, PLUG IN ANY USB FLASH DRIVE AND PLAY MP3/WMA FILES
- FULL FUNCTION 18 KEY IR REMOTE CONTROL

ORDER LINE 1-866-640-1324

2010

FAX LINE 1-905-850-1722

RSC - 2



RetroSound[®]
Modern Sound for your Classic

<http://www.retrosoundcanada.com>

RADIO SYSTEM



CLASSIC SOUND RADIO SYSTEM SPECIFICATIONS:

Tuner Section

FM

Tuning Range (Eu & US Tuning Capable)

87.5 - 107.9MHz

Antenna Terminal

External Antenna Connector

Usable Sensitivity

12.5 dBf

Selectivity

75dB @ 400kHz

Signal to Noise Ratio

62 dB (Stereo), 67 dB (Mono)

Harmonic Distortion @ 1 kHz

0.8% (Stereo), 0.5% (Monaural)

Separation

32 dB @ 1kHz

Frequency Response

30 - 16,000 Hz

AM (Eu & US Tuning Capable)

Tuning Range

530 - 1710 kHz

Antenna Terminal

External Antenna Connector

General

Dimensions (Main Body Only)

3.5"W x 6.7"D x 1.5"H

Power Requirements

10.5 - 14.4V

Current Consumption

Max. 10A

Current Consumption

< 3.5 mA

Output Power

22 x 4w RMS 60x4 Max Power

(@ 14.4V @ 4 ohm @ 1% THD)

Output Impedance

4 - 8 ohm

Low Level Output (4 Channels)

2.5V

AUX Input (Rear)

2V / 6 kΩ

AUX Input (Front)

500 mV / 6 kΩ

ORDER LINE 1-866-640-1324

2010

FAX LINE 1-905-850-1722

RSC - 3



RetroSound[®]
Modern Sound for your Classic

<http://www.retrosoundcanada.com>

RADIO FACEPLATE

GTO / CUTLASS



RS-6467GTOKT



RS-6872GTOKT



RS-6465OCUTKT



RS-6667OCUTKT



RS-6869OCUTKT



RS-7072OCUTKT

SKU#	YEAR	VEHICLE
RS-6467GTOKT	1964-67	PONTIAC GTO
RS-6872GTOKT	1968-72	PONTIAC GTO
RS-6465OCUTKT	1964-65	OLDS CUTLASS 442
RS-6667OCUTKT	1966-67	OLDS CUTLASS 442
RS-6869OCUTKT	1968-69	OLDS CUTLASS 442
RS-7072OCUTKT	1970-72	OLDS CUTLASS 442

ORDER LINE 1-866-640-1324

2010

FAX LINE 1-905-850-1722

RSC - 4



ACCESSORIES

KNOBS



6885ACR



6885ABK



6885FBCRB



6885FBCRB2



6885FCRBKR



EUROKNBACR



EUROKNBABK



EUROKNBFCRBKR



EUROKNBFBKCR



DOKNOBKIT



556KNOBKIT



57KNOBKIT

94" REMOTE IR CABLE



DASH HOLE CUPS



57 CHVY CUPS



68 - 67 NOVA CUPS

REMOTE CONTROL





RetroSound[®]
Modern Sound for your Classic

<http://www.retrosoundcanada.com>

LOUDSPEAKERS

RetroSound Loudspeakers

Why purchase RetroSound™ speakers over your original or "other" commercially available speakers for your classic car? Check out the exploded view below to learn more about the detail and quality that goes into each speaker we make!



RetroSound replacement speakers have set the industry standard in OEM for your classic vehicle!

Designed and tooled from the ground up, the speakers meet the demand of today's high performance amplifiers while maintaining factory dimensions for original location mounting and are compatible with all digital music sources. The "N" Series features 4 models that feature ultra thin 1.77" mounting profiles for fit in virtually any installation application. These 4 models with neodymium magnet structures which are 5 times more powerful than standard speaker magnets, allowing for a substantial reduction in mounting depth and feature enhanced power handling and heat dissipation characteristics. Their Dual Voice Coil design (on 3 models) allows you to connect 2 stereo channels from your radio to one speaker, providing you with maximum sound for a single speaker application!

ORDER LINE 1-866-640-1324

2010

FAX LINE 1-905-850-1722

RSC - 6



RetroSound[®]
Modern Sound for your Classic

<http://www.retrosoundcanada.com>

LOUDSPEAKERS

RetroSound DVC Speaker Technical Specification



ORDER LINE 1-866-640-1324

2010

FAX LINE 1-905-850-1722

RSC - 7



RetroSound[®]
Modern Sound for your Classic

<http://www.retrosoundcanada.com>

LOUDSPEAKERS

RetroSound SVC Speaker Technical Specification



ORDER LINE 1-866-640-1324

2010

FAX LINE 1-905-850-1722

RSC - 8